



## TABLE TENNIS Export





**THE MARKET LEADER**

Sponeta is Europe's leading manufacturer of table tennis tables. The company based in Thuringia, Germany, crafts quality products for several brands hence table tennis tables produced in Schlotheim are successfully applied for the sections of leisure time, training and the competition sector as well – worldwide.

**TRADITION**

Sponeta's trade is based on the age-old cordage and net manufacturing in Thuringia. Emerging from the sole manufacturing of sporting goods, the production of table tennis tables developed during the early 1970s, including carefully handcrafted nets and tables. An enormous know-how concerning the section of table tennis has been built and continuously expanded since more than four decades. Trusting its tradition yet constantly moving forward: this is Sponeta.

**QUALITY** „Made in Germany“ has become a valuable brand within global competition. Since several years Sponeta represents this trademark by constantly presenting highquality products. Most important regarding this is a comprehensive quality management and above all the manufacturing is certified in accordance with DIN EN ISO 9001:2008. Every single new product has to pass the in-house laboratory check as well as an extended test regarding its market maturity.

The **MANUFACTURING** is solely taking place at our own plant in Schlotheim, Thuringia, using state-of-the-art technologies. Here we're producing table tennis tables for our home brand as well as for many other brands in Germany and abroad. Furthermore the fact that different brands trust in our quality of manufacturing and production is a daily acknowledgement to continue along



our current path.

Our **PRODUCT DEVELOPMENT** is in the capable hands of Sponeta's professionals weaving in latest available technologies such as 3D simulation and computer-aided design. As the traditional table tennis sector is as well influenced by constant change we're keeping an eye on the market to gather current trends.

The **WORLDWIDE PRESENCE** following long-term and sustainable market orientation is one of Sponeta's core competences next to distribution via national and international

specialised trade as well as wholesale. We're well equipped with decades-long experience in export and hence are represented in over 80 countries. Doing some straight talking: Looking for a table tennis table you will most certainly pass Sponeta.

The **DISTRIBUTION** of our tables is transacted centrally via a modern logistics centre so that drop shipments at home and abroad can be handled quickly and thoroughly, as well as the shipping of full container loads via ocean transport. Next to these first-rate services Sponeta's central location in Germany and Europe is the major benefit of our manufacturing base in Thuringia.

**COMMITMENT TO THE SPORTS** means everything to us. Since many years Sponeta is the host of the international renowned Sponeta Cup which is Thuringia's main open table tennis tournament. Sponeta has also been the main sponsor of the World Veterans Table Tennis Championships in Bremen, Germany and engages in international, national as well as local competitions such as tournaments for the elderly as well as young people and challenged persons. Further sponsoring activity includes the funding of sports clubs and especially youth sports as well as being the main sponsor of Post SV Mühlhausen, member of the top German professional table tennis league (Bundesliga).





---

**S1** LINE

---

**S2** LINE

---

**S3** LINE

---

**S4** LINE

---

**S5** LINE

---

**S6** LINE

---

**S7** LINE

---

**S8** LINE

---

**DESIGN LINE**

---



















**ACCESSORIES**

---

**TECHNICAL INFORMATION**

---



					<p><b>Classes/Standards</b></p>
					<p><b>Field of use</b></p>
				<p><b>Tabletop</b></p>	
				<p><b>Undercarriage</b></p>	
				<p><b>Net set</b></p>	
				<p><b>Locking system</b></p>	
				<p><b>Wheels</b></p>	
				<p><b>Special features</b></p>	
				<p>(International Table Tennis Federation) <b>ITTF</b></p>	
				<p><b>Dimensions</b></p>	
				<p><b>Packaging</b></p>	
				<p><b>Weight</b></p>	
					<p><b>Assembly/-video</b></p>





S 1-13 i



S 1-12 i



S1 LINE



Quality  
made in  
Germany

Art.-Nr. 210.DEFG/Hi

Delivery will be made  
without bats and balls.  
Subject to technical alterations.



## S 1-12 i / S 1-13 i



**Field of use**  
Indoors



**Tabletop**  
3tecWOOD 19mm



**Net set**  
Club-EN-stationary



**Undercarriage**  
Automatic (type 4a), black



**Wheels**  
4 double wheels Ø 125mm,  
2 wheels are manoeuvrable



**Locking system**  
Hook system



**Special features**  
Bat and ball holder, safety bar



**Assembly video**  
<http://q-r.to/05t0>



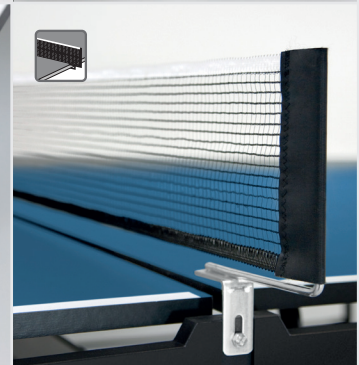
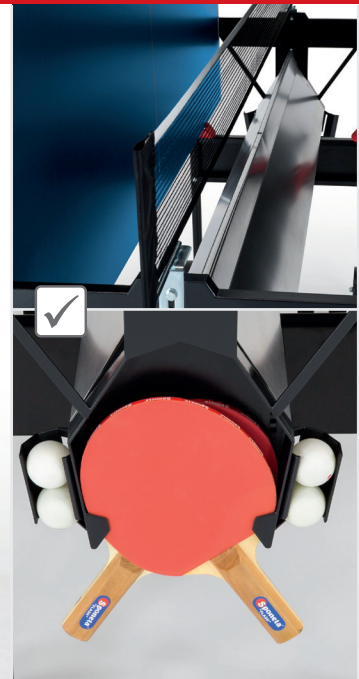

**S 1-12 i**  
**S 1-13 i**

**Service:** Assembly instructions and information for users are included in delivery. Instruction for use, as well as the service code number (for technical questions or complaints) are to be found on the underside of the table top.

**Warranty claim:** 2 years (according to legal regulations).

**Security advice:** The table tennis table has to be placed on level ground and should be secured against rolling away or tipping over.

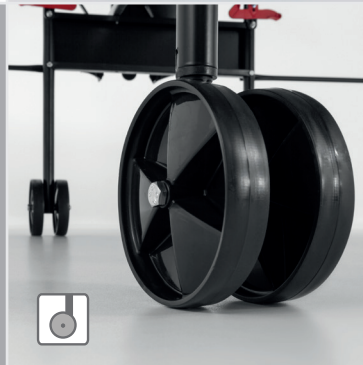

**Field of use**

Indoors. Perfect for beginners. In the playback-position for sole training, too.



**Tabletop**

3tecWOOD 19mm, coated several times, green or blue.



**Net set**

Club-EN-stationary. Net: black. Net set can remain on the table in the playback- or in storage position, it also increases the stability of the table.



**Locking system**

Hook-system. Simple and automatic click-mechanism in the storage and playing position of the table.



**Undercarriage**

Tubular-profile 25mm, black, powder-coated.



**Wheels**

4 double wheels Ø 125mm, 2 wheels are manoeuvrable, allow moving the table on rough ground.



**Special features**

Bat and ball holder on both sides of the table, for keeping 4 balls and 2 bats each. Safety bar prevents climbing between or staying between the two tabletops.



**Assembly video**

Practical supplement to the assembly instruction. Step by step to the finished table tennis table - clearly explained in the video. Available via QR code. **Link:** <http://q-r.to/05t0>



**Dimensions**

Storage position: L=159cm (with net 180cm) x W=66,5cm x H=188,5cm  
Playing position: L=274cm x W (with net)=180cm x H=76cm  
(Tabletop in accordance with international dimensions)



**Packaging**

Type A (single carton)  
H=158cm x L=142cm x W=10cm



**Weight**

Table tennis table 64 kg,  
with packaging 69,5 kg



**S 1-13 e**

**10 years warranty<sup>1)</sup>**

<sup>1)</sup>for outdoor melamine resin boards according to our warranty terms



**S 1-12 e**



**S1 LINE**



**Quality made in Germany**

**Art.-Nr. 240.DEFG/HI**

Delivery will be made without bats and balls.  
Subject to technical alterations.



## S 1-12 e / S 1-13 e



**Field of use**  
Outdoors



**Tabletop**  
\* Melamine resin board 4mm, metal frame 36mm



**Net set**  
Club-EN-stationary



**Undercarriage**  
Automatic (type 4a), black



**Wheels**  
4 double wheels Ø 125mm,  
2 wheels are manoeuvrable



**Locking system**  
Hook system



**Special features**  
Bat and ball holder, safety bar



**Assembly video**  
<http://q-r.to/05yU>



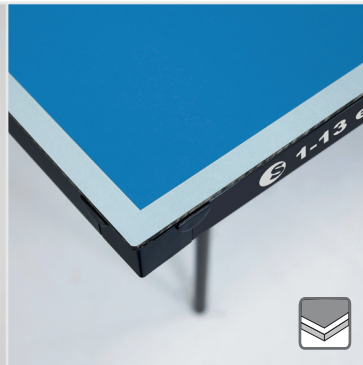

**S 1-12 e**  
**S 1-13 e**

**Service:** Assembly instructions and information for users are included in delivery. Instruction for use, as well as the service code number (for technical questions or complaints) are to be found on the underside of the table top.

**Warranty claim:** 2 years (according to legal regulations).

**Security advice:** The table tennis table has to be placed on level ground and should be secured against rolling away or tipping over.



**Field of use**  
Outdoors. Perfect for beginners. In the playback-position for sole training, too.



**Tabletop**  
\* Melamine resin board 4mm, green or blue, limited impact-resistant, resistant against dampness, metal frame 36mm.



**Net set**  
Club-EN-stationary. Net: black. Net set can remain on the table in the playback- or in storage position, it also increases the stability of the table.



**Locking system**  
Hook-system. Simple and automatic click-mechanism in the storage and playing position of the table.



**Undercarriage**  
Tubular-profile 25mm, black, powder-coated.



**Wheels**  
4 double wheels Ø 125mm, 2 wheels are manoeuvrable, allow moving the table on rough ground.



**Special features**  
Bat and ball holder on both sides of the table, for keeping 4 balls and 2 bats each. Safety bar prevents climbing between or staying between the two tabletops.



**Assembly video**  
Practical supplement to the assembly instruction. Step by step to the finished table tennis table - clearly explained in the video. Available via QR code. [Link: http://q-r.to/05yU](http://q-r.to/05yU)



**Dimensions**  
Storage position: L=159cm (with net 180cm) x W=72cm x H=188,5cm  
Playing position: L=274cm x W (with net)=180cm x H=76cm  
(Tabletop in accordance with international dimensions)



**Packaging**  
Type A (single carton)  
H=158cm x L=142cm x W=10cm



**Weight**  
Table tennis table 47,5 kg, with packaging 53 kg



S 1-27 i



S 1-26 i



S1 LINE



Quality  
made in  
Germany

Art.-Nr. 211.DEFG/HI

Delivery will be made  
without bats and balls.  
Subject to technical alterations.



## S 1-26 i / S 1-27 i



**Field of use**  
Indoors



**Tabletop**  
3tecWOOD 16mm, metal frame 36mm



**Net set**  
Club-EN-stationary



**Undercarriage**  
Automatic (type 4a), black



**Wheels**  
4 double wheels Ø 125mm,  
2 wheels are manoeuvrable



**Locking system**  
Hook system



**Special features**  
Bat and ball holder, safety bar



**Assembly video**  
<http://q-r.to/05z7>



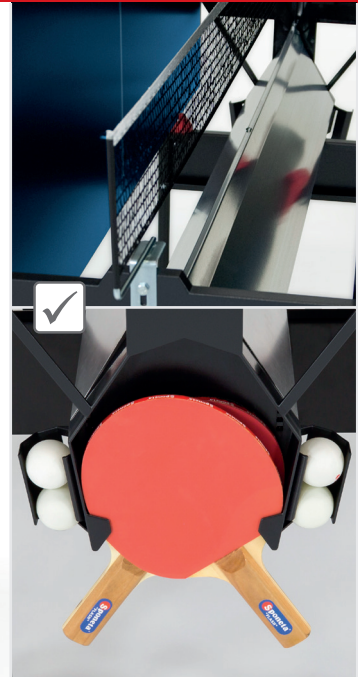

**S 1-26 i**  
**S 1-27 i**

**Service:** Assembly instructions and information for users are included in delivery. Instruction for use, as well as the service code number (for technical questions or complaints) are to be found on the underside of the table top.

**Warranty claim:** 2 years (according to legal regulations).

**Security advice:** The table tennis table has to be placed on level ground and should be secured against rolling away or tipping over.

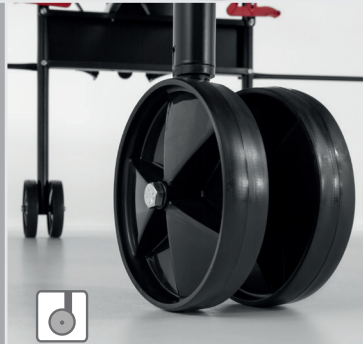

**Field of use**

Indoors. Perfect for beginners. In the playback-position for sole training, too.



**Tabletop**

3tecWOOD 16mm, coated several times, green or blue, metal frame 36mm.



**Net set**

Club-EN-stationary. Net: black. Net set can remain on the table in the playback- or in storage position, it also increases the stability of the table.



**Locking system**

Hook-system. Simple and automatic click-mechanism in the storage and playing position of the table.



**Undercarriage**

Tubular-profile 25mm, black, powder-coated.



**Wheels**

4 double wheels Ø 125mm, 2 wheels are manoeuvrable, allow moving the table on rough ground.



**Special features**

Bat and ball holder on both sides of the table, for keeping 4 balls and 2 bats each. Safety bar prevents climbing between or staying between the two tabletops.



**Assembly video**

Practical supplement to the assembly instruction. Step by step to the finished table tennis table - clearly explained in the video. Available via QR code. [Link: http://q-r.to/05z7](http://q-r.to/05z7)



**Dimensions**

Storage position: L=159cm (with net 180cm) x W=66,5cm x H=188,5cm  
Playing position: L=274cm x W (with net)=180cm x H=76cm  
(Tabletop in accordance with international dimensions)



**Packaging**

Type A (single carton)  
H=158cm x L=142cm x W=12cm



**Weight**

Table tennis table 62,5 kg,  
with packaging 68 kg





S 1-43 i



S 1-42 i



S1 LINE



Quality  
made in  
Germany

Art.-Nr. 214.DEFG/Hi

Delivery will be made  
without bats and balls.  
Subject to technical alterations.



## S 1-42 i / S 1-43 i



**Field of use**  
Indoors



**Tabletop**  
3tecWOOD 19mm



**Net set**  
Basic stationary



**Undercarriage**  
Compact (Type 4b), black



**Wheels**  
4 double wheels Ø 125mm,  
all wheels are manoeuvrable



**Locking system**  
Rotating handle system



**Special features**  
Bat and ball holder



**Assembly video**  
<http://q-r.to/05zL>

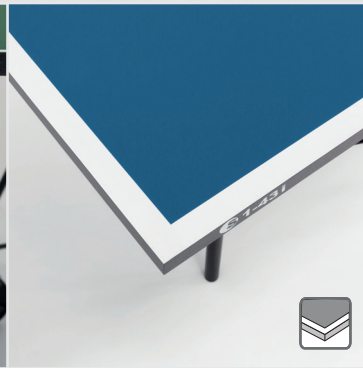
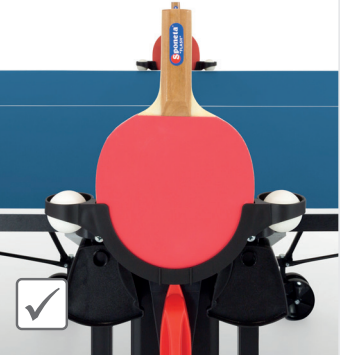

**Service:** Assembly instructions and information for users are included in delivery. Instruction for use, as well as the service code number (for technical questions or complaints) are to be found on the underside of the table top.

**Warranty claim:** 2 years (according to legal regulations).

**Security advice:** The table tennis table has to be placed on level ground and should be secured against rolling away or tipping over.



**S 1-42 i**  
**S 1-43 i**



**Field of use**  
Indoors. Perfect for beginners.  
In the playback-position for sole training, too.



**Tabletop**  
3tecWOOD 19mm, coated several times,  
green or blue.



**Net set**  
Basic stationary. Net: black. Net set can remain  
on the table in the playback- or in storage position.



**Locking system**  
Rotating handle system. Unlocking by turning the  
handle.



**Undercarriage**  
Tubular-profile 25mm, black, powder-coated.



**Wheels**  
4 double wheels Ø 125mm, all wheels are manoeuvrable,  
allow moving the table on rough ground.



**Special features**  
Bat and ball holder on both sides of the table, for keeping 2 balls and  
1 bat each.



**Assembly video**  
Practical supplement to the assembly instruction. Step by step to the  
finished table tennis table - clearly explained in the video. Available  
via QR code. [Link: http://q-r.to/05zL](http://q-r.to/05zL)



**Dimensions**  
Storage position: L=159cm (with net 165,5cm) x W=74cm x H=155,5cm  
Playing position: L=274cm x W (with net)=165,5cm x H=76cm  
(Tabletop in accordance with international dimensions)



**Packaging**  
Type A (single carton)  
H=158cm x L=142cm x W=10cm



**Weight**  
Table tennis table 63 kg,  
with packaging 68,5 kg



S 1-43 e

10 years warranty<sup>1)</sup>

<sup>1)</sup>for outdoor melamine resin boards according to our warranty terms



S 1-42 e



S1 LINE



Quality made in Germany

Art.-Nr. 216.DEFG/HI

Delivery will be made without bats and balls.  
Subject to technical alterations.



## S 1-42 e / S 1-43 e



**Field of use**  
Outdoors



**Tabletop**  
Melamine resin board 4mm, metal frame 36mm



**Net set**  
Basic stationary



**Undercarriage**  
Compact (Type 4b), black



**Wheels**  
4 double wheels Ø 125mm,  
all wheels are manoeuvrable



**Locking system**  
Rotating handle system



**Special features**  
Bat and ball holder



**Assembly video**  
<http://q-r.to/05zZ>



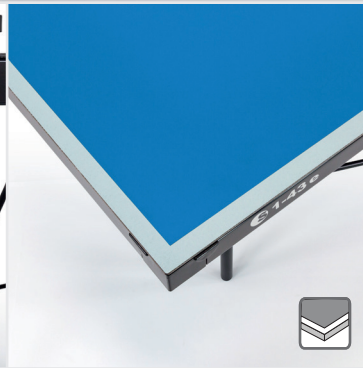

**S 1-42 e**  
**S 1-43 e**

**Service:** Assembly instructions and information for users are included in delivery. Instruction for use, as well as the service code number (for technical questions or complaints) are to be found on the underside of the table top.

**Warranty claim:** 2 years (according to legal regulations).

**Security advice:** The table tennis table has to be placed on level ground and should be secured against rolling away or tipping over.



**Field of use**  
Outdoors. Perfect for beginners. In the playback-position for sole training, too.



**Tabletop**  
\* Melamine resin board 4mm, green or blue, limited impact-resistant, resistant against dampness, metal frame 36mm.



**Net set**  
Basic stationary. Net: black. Net set can remain on the table in the playback- or in storage position.



**Locking system**  
Rotating handle system. Unlocking by turning the handle.



**Undercarriage**  
Tubular-profile 25mm, black, powder-coated.



**Wheels**  
4 double wheels Ø 125mm, all wheels are manoeuvrable. Allow moving the table on rough ground.



**Special features**  
Bat and ball holder on both sides of the table, for keeping 2 balls and 1 bat each.



**Assembly video**  
Practical supplement to the assembly instruction. Step by step to the finished table tennis table - clearly explained in the video. Available via QR code. [Link: http://q-r.to/05zZ](http://q-r.to/05zZ)



**Dimensions**  
Storage position: L=159cm (with net 165,5cm) x W=74cm x H=155,5cm  
Playing position: L=274cm x W (with net)=165,5cm x H=76cm  
(Tabletop in accordance with international dimensions)



**Packaging**  
Type A (single carton)  
H=158cm x L=142cm x W=10cm



**Weight**  
Table tennis table 47,5 kg, with packaging 53 kg



S 1-53 i



S 1-52 i



**S1 LINE**



**Quality  
made in  
Germany**

**Art.-Nr. 275.DEFG/Hi**

Delivery will be made  
without bats and balls.  
Subject to technical alterations.



## S 1-52 i / S 1-53 i



**Field of use**  
Indoors



**Tabletop**  
3tecWOOD 16mm



**Net set**  
Start



**Undercarriage**  
Standard (type 2), black



**Wheels**  
2 wheels Ø 125mm for each tabletop  
for vertical transport



**Locking system**  
Screw connection



**Special features**  
Tabletop connector



**Assembly video**  
<http://q-r.to/05zf>

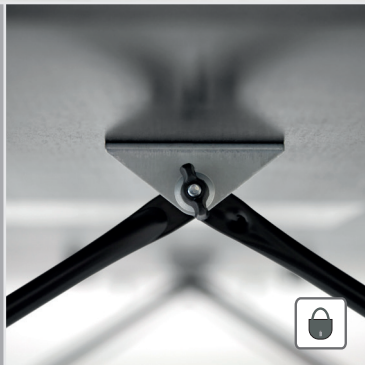
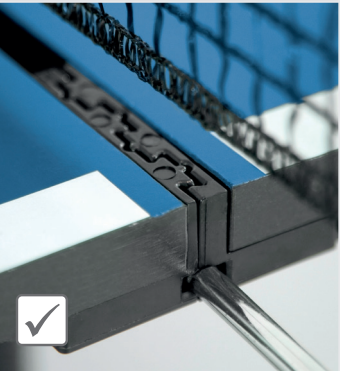

**S 1-52 i**  
**S 1-53 i**

**Service:** Assembly instructions and information for users are included in delivery. Instruction for use, as well as the service code number (for technical questions or complaints) are to be found on the underside of the table top.

**Warranty claim:** 2 years (according to legal regulations).

**Security advice:** The table tennis table has to be placed on level ground and should be secured against rolling away or tipping over.



**Field of use**  
Indoors. Perfect for beginners.



**Tabletop**  
3tecWOOD 16mm, coated several times, green or blue.



**Net set**  
Start. Net black.



**Locking system**  
Screw connection. For fixation of the stand legs in the playing position.



**Undercarriage**  
Tubular-profile 25mm, black, powder-coated.



**Wheels**  
2 wheels Ø 125mm for each side for vertical transport.



**Special features**  
Tabletop connectors and net set improve the stability of the tabletop.



**Assembly video**  
Practical supplement to the assembly instruction. Step by step to the finished table tennis table - clearly explained in the video. Available via QR code. [Link: http://q-r.to/05zf](http://q-r.to/05zf)



**Dimensions**  
Storage position: L=152,5cm (with net) x W=10cm x H=142cm  
Playing position: L=274cm x W (with net)=180cm x H=76cm  
(Tabletop in accordance with international dimensions)



**Packaging**  
Type A (single carton)  
H=158cm x L=142cm x W=10cm



**Weight**  
Table tennis table 53 kg,  
with packaging 58,5 kg





S 1-53 e

10 years warranty<sup>1)</sup>

<sup>1)</sup>for outdoor melamine resin boards according to our warranty terms



S 1-52 e



S1 LINE



Quality  
made in  
Germany

Art.-Nr. 277.DEFG/HI

Delivery will be made without bats and balls.  
Subject to technical alterations.



## S 1-52 e / S 1-53 e



**Field of use**  
Outdoors



**Tabletop**  
\* Melamine resin board 3,5mm,  
metal frame 36mm



**Net set**  
Start



**Undercarriage**  
Standard (type 2), black



**Locking system**  
Screw connection



**Special features**  
Tabletop connector



**Assembly video**  
<http://q-r.to/bb3RVF>

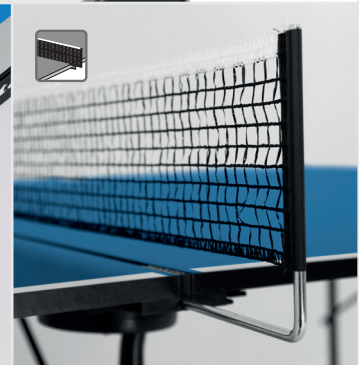
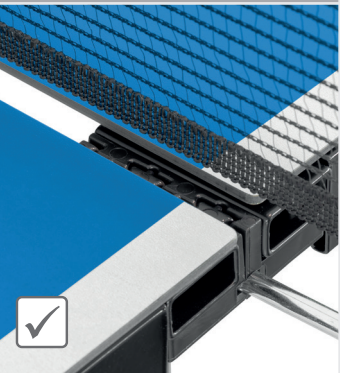

**S 1-52 e**  
**S 1-53 e**

**Service:** Assembly instructions and information for users are included in delivery. Instruction for use, as well as the service code number (for technical questions or complaints) are to be found on the underside of the table top.

**Warranty claim:** 2 years (according to legal regulations).

**Security advice:** The table tennis table has to be placed on level ground and should be secured against rolling away or tipping over.



**Field of use**  
Indoors. Perfect for beginners.



**Tabletop**  
\* Melamine resin board 3.5mm, green or blue, limited impact-resistant, resistant against dampness, metal frame 36mm.



**Net set**  
Start. Net black.



**Locking system**  
Screw connection. For fixation of the stand legs in the playing position.



**Undercarriage**  
Tubular-profile 25mm, black, powder-coated.



**Special features**  
Tabletop connectors and net set improve the stability of the tabletop.



**Assembly video**  
Practical supplement to the assembly instruction. Step by step to the finished table tennis table - clearly explained in the video. Available via QR code. [Link: http://q-r.to/bb3RVF](http://q-r.to/bb3RVF)



**Dimensions**  
Storage position: L=152,5cm (with net) x W=10cm x H=142cm  
Playing position: L=274cm x W (with net)=180cm x H=76cm  
(Tabletop in accordance with international dimensions)



**Packaging**  
Type A (single carton)  
H=158cm x L=142cm x W=10cm



**Weight**  
Table tennis table 43 kg,  
with packaging 48,5 kg



S 1-73 i



S 1-72 i



S1 LINE



Quality  
made in  
Germany

Art.-Nr. 220.DEFG/Hi

Delivery will be made  
without bats and balls.  
Subject to technical alterations.



## S 1-72 i / S 1-73 i



**Field of use**  
Indoors



**Tabletop**  
3tecWOOD 19mm



**Net set**  
Club-EN-stationary



**Undercarriage**  
Compact (Type 4b), black



**Wheels**  
4 wheels Ø 125mm, 2 wheels are manoeuvrable



**Locking system**  
Rotating handle system



**Special features**  
Bat and ball holder



**Assembly video**  
<http://q-r.to/05zk>



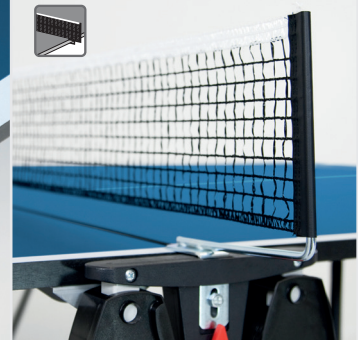
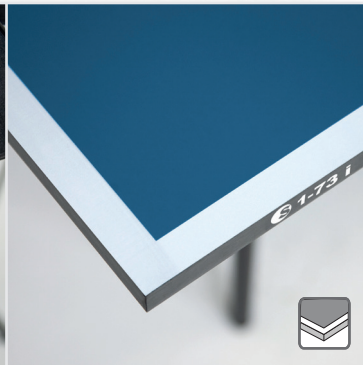
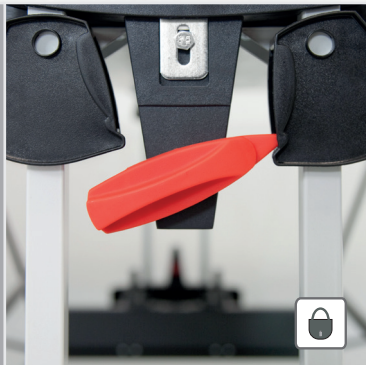

**S 1-72 i**  
**S 1-73 i**

**Service:** Assembly instructions and information for users are included in delivery. Instruction for use, as well as the service code number (for technical questions or complaints) are to be found on the underside of the table top.

**Warranty claim:** 2 years (according to legal regulations).

**Security advice:** The table tennis table has to be placed on level ground and should be secured against rolling away or tipping over.

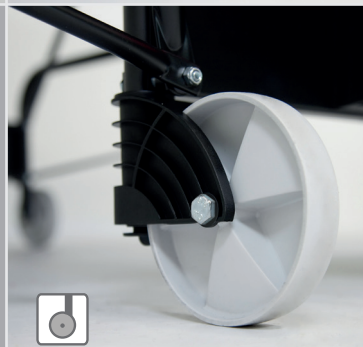

**Field of use**

Indoors. Perfect for beginners. In the playback-position for sole training, too.



**Tabletop**

3tecWOOD 19mm, coated several times, green or blue.



**Net set**

Club-EN-stationary. Net: black. Net set can remain on the table in the playback- or in storage position.



**Locking system**

Rotating handle system. Unlocking by turning the handle.



**Undercarriage**

Tubular-profile 25mm, black, powder-coated.



**Wheels**

4 wheels Ø 125mm, 2 wheels are manoeuvrable.



**Special features**

Bat and ball holder on both sides of the table, for keeping 4 balls and 2 bats each.



**Assembly video**

Practical supplement to the assembly instruction. Step by step to the finished table tennis table - clearly explained in the video. Available via QR code. [Link: http://q-r.to/05zk](http://q-r.to/05zk)



**Dimensions**

Storage position: L=166,5cm (with net 180cm) x W=69cm x H=163cm  
Playing position: L=274cm x W (with net)=180cm x H=76cm  
(Tabletop in accordance with international dimensions)



**Packaging**

Type A (single carton)  
H=158cm x L=142cm x W=10cm



**Weight**

Table tennis table 63 kg,  
with packaging 68,5 kg



S 1-73 e

10 years  
warranty<sup>1)</sup>

<sup>1)</sup>for outdoor melamine resin boards  
according to our warranty terms



S 1-72 e



S1 LINE



Quality  
made in  
Germany

Art.-Nr. 222.DEFG/HI

Delivery will be made  
without bats and balls.  
Subject to technical alterations.



## S 1-72 e / S 1-73 e



**Field of use**  
Outdoors



**Tabletop**  
\* Melamine resin board 4mm, metal frame 36mm



**Net set**  
Club-EN-stationary



**Undercarriage**  
Compact (type 4b), black



**Wheels**  
4 wheels Ø 125mm, 2 wheels are manoeuvrable



**Locking system**  
Rotating handle system



**Special features**  
Bat and ball holder



**Assembly video**  
<http://q-r.to/05zn>

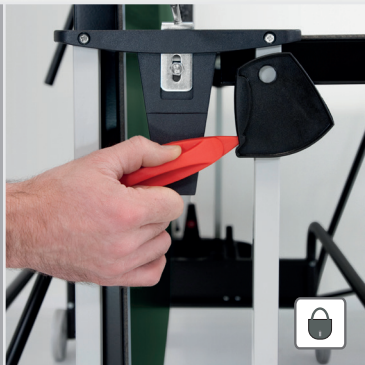

**S 1-72 e**  
**S 1-73 e**

**Service:** Assembly instructions and information for users are included in delivery. Instruction for use, as well as the service code number (for technical questions or complaints) are to be found on the underside of the table top.

**Warranty claim:** 2 years (according to legal regulations).

**Security advice:** The table tennis table has to be placed on level ground and should be secured against rolling away or tipping over.



**Field of use**

Outdoors. Perfect for beginners. In the playback-position for sole training, too.



**Tabletop**

\* Melamine resin board 4mm, green or blue, limited impact-resistant, resistant against dampness, metal frame 36mm.



**Net set**

Club-EN-stationary. Net: black. Net set can remain on the table in the playback- or in storage position.



**Locking system**

Rotating handle system. Unlocking by turning the handle.



**Undercarriage**

Tubular-profile 25mm, black, powder-coated.



**Wheels**

4 wheels Ø 125mm, 2 wheels are manoeuvrable.



**Special features**

Bat and ball holder on both sides of the table, for keeping 4 balls and 2 bats each.



**Assembly video**

Practical supplement to the assembly instruction. Step by step to the finished table tennis table - clearly explained in the video. Available via QR code. [Link: http://q-r.to/05zn](http://q-r.to/05zn)



**Dimensions**

Storage position: L=166,5cm (with net 180cm) x W=69cm x H=163cm  
Playing position: L=274cm x W (with net)=180cm x H=76cm  
(Tabletop in accordance with international dimensions)



**Packaging**

Type A (single carton)  
H=158cm x L=142cm x W=10cm



**Weight**

Table tennis table 48 kg, with packaging 53,5 kg





S 2-73 i



S 2-72 i



S2 LINE



Quality  
made in  
Germany

Art.-Nr. 236.DEFG/Hi

Delivery will be made  
without bats and balls.  
Subject to technical alterations.



## S 2-72 i / S 2-73 i



**Field of use**  
Indoors



**Tabletop**  
3tecWOOD 19mm



**Net set**  
Club-EN-stationary



**Undercarriage**  
Compact (Type 4b), black and fire red



**Wheels**  
4 double wheels Ø 125mm,  
2 wheels are manoeuvrable



**Locking system**  
SMS (Smart Manual System)



**Special features**  
Bat and ball holder



**Assembly video**  
<http://q-r.to/05zo>

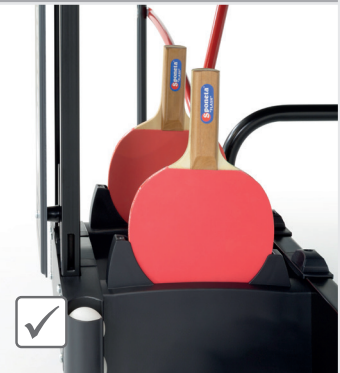

**S 2-72 i**  
**S 2-73 i**

**Service:** Assembly instructions and information for users are included in delivery. Instruction for use, as well as the service code number (for technical questions or complaints) are to be found on the underside of the table top.

**Warranty claim:** 2 years (according to legal regulations).

**Security advice:** The table tennis table has to be placed on level ground and should be secured against rolling away or tipping over.

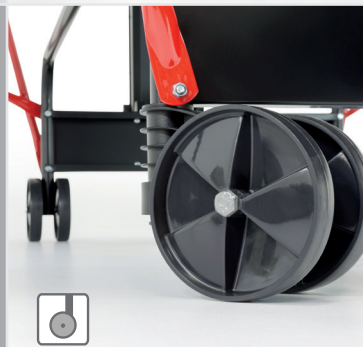

**Field of use**  
Indoors. Perfect for beginners.  
In the playback-position for sole training, too.



**Tabletop**  
3tecWOOD 19mm, coated several times,  
green or blue.



**Net set**  
Club-EN-stationary. Net: black. Net set can remain  
on the table in the playback- or in storage position.



**Locking system**  
SMS (Smart Manual System). Handle visible from all  
sides and in any position. Drawbar underneath the  
tabletop unlocks both of the safety devices simulta-  
neously. Simple and automatic click-mechanism in  
storage and playing position of the table.



**Undercarriage**  
Tubular-profile 25mm, black and fire red, powder-  
coated.



**Wheels**  
4 double wheels Ø 125mm, 2 wheels are manoeuvrable,  
allow moving the table on rough ground.



**Special features**  
Bat and ball holder on both sides of the table, for keeping 4 balls and  
2 bats each.



**Assembly video**  
Practical supplement to the assembly instruction. Step by step to the  
finished table tennis table - clearly explained in the video. Available  
via QR code. [Link: http://q-r.to/05zo](http://q-r.to/05zo)



**Dimensions**  
Storage position: L=163cm (with net 180cm) x W=69cm x H=163cm  
Playing position: L=274cm x W (with net)=180cm x H=76cm  
(Tabletop in accordance with international dimensions)



**Packaging**  
Type A (single carton)  
H=158cm x L=142cm x W=10cm



**Weight**  
Table tennis table 65,5 kg,  
with packaging 71 kg



S 2-73 e

10 years warranty<sup>1)</sup>

<sup>1)</sup>for outdoor melamine resin boards according to our warranty terms



S 2-72 e



S2 LINE



Quality made in Germany

Art.-Nr. 237.DEFG/HI

Delivery will be made without bats and balls.  
Subject to technical alterations.



## S 2-72 e / S 2-73 e



**Field of use**  
Outdoors



**Tabletop**  
\* Melamine resin board 4mm, metal frame 36mm



**Net set**  
Club-EN-stationary



**Undercarriage**  
Compact (Type 4b), black and fire red



**Wheels**  
4 double wheels Ø 125mm,  
2 wheels are manoeuvrable



**Locking system**  
SMS (Smart Manual System)



**Special features**  
Bat and ball holder



**Assembly video**  
<http://q-r.to/05zq>



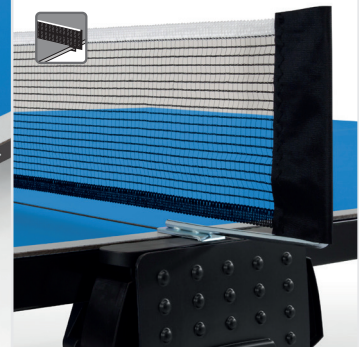

**S 2-72 e**  
**S 2-73 e**

**Service:** Assembly instructions and information for users are included in delivery. Instruction for use, as well as the service code number (for technical questions or complaints) are to be found on the underside of the table top.

**Warranty claim:** 2 years (according to legal regulations).

**Security advice:** The table tennis table has to be placed on level ground and should be secured against rolling away or tipping over.



**Field of use**  
Outdoors. Perfect for beginners. In the playback-position for sole training, too.



**Tabletop**  
\* Melamine resin board 4mm, green or blue, limited impact-resistant, resistant against dampness, metal frame 36mm.



**Net set**  
Club-EN-stationary. Net: black. Net set can remain on the table in the playback- or in storage position.



**Locking system**  
SMS (Smart Manual System). Handle visible from all sides and in any position. Drawbar underneath the tabletop unlocks both of the safety devices simultaneously. Simple and automatic click-mechanism in storage and playing position of the table.



**Undercarriage**  
Tubular-profile 25mm, black and fire red, powder-coated.



**Wheels**  
4 double wheels Ø 125mm, 2 wheels are manoeuvrable, allow moving the table on rough ground.



**Special features**  
Bat and ball holder on both sides of the table, for keeping 4 balls and 2 bats each.



**Assembly video**  
Practical supplement to the assembly instruction. Step by step to the finished table tennis table - clearly explained in the video. Available via QR code. [Link: http://q-r.to/05zq](http://q-r.to/05zq)



**Dimensions**  
Storage position: L=163cm (with net 180cm) x W=69cm x H=163cm  
Playing position: L=274cm x W (with net)=180cm x H=76cm  
(Tabletop in accordance with international dimensions)



**Packaging**  
Type A (single carton)  
H=158cm x L=142cm x W=10cm



**Weight**  
Table tennis table 51 kg, with packaging 56,5 kg



S 3-47 i



S 3-46 i



**S3 LINE**



Art.-Nr. 202.DEFG/HI

Delivery will be made without bats and balls.  
Subject to technical alterations.



**S 3-46 i / S 3-47 i**



**Field of use**  
Indoors



**Tabletop**  
3tecWOOD 19mm, metal frame 36mm



**Net set**  
Pilot-II-EN-stationary



**Undercarriage**  
Automatic (type 4a), window grey



**Wheels**  
4 double wheels Ø 125mm,  
all wheels are manoeuvrable



**Locking system**  
Hook system



**Special features**  
Bat and ball holder, safety bar



**Assembly video**  
<http://q-r.to/05zl>



**S 3-46 i**  
**S 3-46 i**

**Service:** Assembly instructions and information for users are included in delivery. Instruction for use, as well as the service code number (for technical questions or complaints) are to be found on the underside of the table top.

**Warranty claim:** 2 years (according to legal regulations).

**Security advice:** The table tennis table has to be placed on level ground and should be secured against rolling away or tipping over.



**Field of use**

Indoors. For active leisure time. In playback-position for sole training, too.



**Tabletop**

3tecWOOD 19mm, coated several times, green or blue, metal frame 36mm.



**Net set**

Pilot-II-EN-stationary. Net: black. Net set can remain on the table in the playback- or in storage position, it also increases the stability of the table.



**Locking system**

Hook system. Simple and automatic click-mechanism in storage position of the table.



**Undercarriage**

Square-profile 25 x 25mm, window grey, powder-coated.



**Wheels**

4 double wheels Ø 125mm, all wheels are manoeuvrable, allow moving the table on rough ground.



**Special features**

Bat and ball holder on both sides of the table, for keeping 4 balls and 2 bats each. Safety bar prevents from climbing between or staying between the two table tops.



**Assembly video**

Practical supplement to the assembly instruction. Step by step to the finished table tennis table - clearly explained in the video. Available via QR code. [Link: http://q-r.to/05zl](http://q-r.to/05zl)



**Dimensions**

Storage position: L=159cm (with net 180cm) x W=65cm x H=187cm  
Playing position: L=274cm x W (with net)=180cm x H=76cm  
(Tabletop in accordance with international dimensions)



**Packaging**

Type A (single carton)  
H=158cm x L=142cm x W=12cm



**Weight**

Table tennis table 71 kg, with packaging 76,5 kg





S 3-47 e

**10 years warranty<sup>1)</sup>**

<sup>1)</sup>for outdoor melamine resin boards according to our warranty terms



S 3-46 e



**S3 LINE**



**Quality made in Germany**

**Art.-Nr. 206.DEFG/HI**

Delivery will be made without bats and balls.  
Subject to technical alterations.



## S 3-46 e / S 3-47 e



**Field of use**  
Outdoors



**Tabletop**  
\*\* Melamine resin board 5mm, metal frame 36mm



**Net set**  
Pilot-II-EN-stationary



**Undercarriage**  
Automatic (type 4a), window grey



**Wheels**  
4 double wheels Ø 125mm,  
all wheels are manoeuvrable



**Locking system**  
Hook system



**Special features**  
Bat and ball holder, safety bar



**Assembly video**  
<http://q-r.to/05zu>

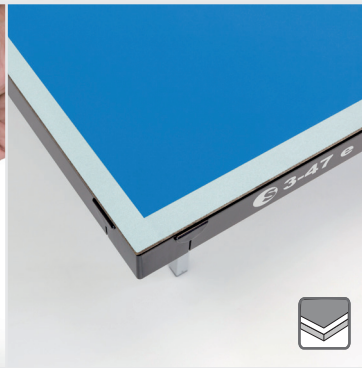
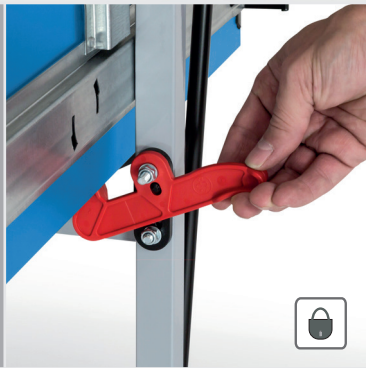

**S 3-46 e**  
**S 3-46 e**

**Service:** Assembly instructions and information for users are included in delivery. Instruction for use, as well as the service code number (for technical questions or complaints) are to be found on the underside of the table top.

**Warranty claim:** 2 years (according to legal regulations).

**Security advice:** The table tennis table has to be placed on level ground and should be secured against rolling away or tipping over.

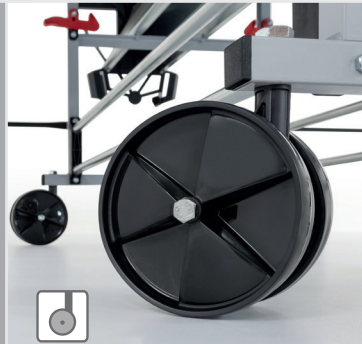

**Field of use**

Outdoors. For active leisure time. In playback-position for sole training, too.



**Tabletop**

\*\* Melamine resin board 5mm, green or blue, limited impact-resistant, resistant against dampness, metal frame 36mm.



**Net set**

Pilot-II-EN-stationary. Net: black. Net set can remain on the table in the playback- or in storage position, it also increases the stability of the table.



**Locking system**

Hook system. Simple and automatic click-mechanism in storage position of the table.



**Undercarriage**

Square-profile 25 x 25mm, window grey, powder-coated.



**Wheels**

4 double wheels Ø 125mm, all wheels are manoeuvrable, allow moving the table on rough ground.



**Special features**

Bat and ball holder on both sides of the table, for keeping 4 balls and 2 bats each. Safety bar prevents from climbing between or staying between the two table tops.



**Assembly video**

Practical supplement to the assembly instruction. Step by step to the finished table tennis table - clearly explained in the video. Available via QR code. [Link: http://q-r.to/05zu](http://q-r.to/05zu)



**Dimensions**

Storage position: L=159cm (with net 180cm) x W=65cm x H=187cm  
Playing position: L=274cm x W (with net)=180cm x H=76cm  
(Tabletop in accordance with international dimensions)



**Packaging**

Type A (single carton)  
H=158cm x L=142cm x W=10cm



**Weight**

Table tennis table 53 kg,  
with packaging 58,5 kg



S 3-73 i



S 3-72 i



S3 LINE



Quality  
made in  
Germany

Art.-Nr. 233.DEFG/Hi

Delivery will be made  
without bats and balls.  
Subject to technical alterations.



## S 3-72 i / S 3-73 i



**Field of use**  
Indoors



**Tabletop**  
3tecWOOD 19mm, metal frame 36mm



**Net set**  
Pilot-II-EN-stationary



**Undercarriage**  
Compact (type 4b), window grey



**Wheels**  
4 double wheels Ø 125mm,  
2 wheels are manoeuvrable



**Locking system**  
SMS (Smart Manual System)



**Special features**  
Bat and ball holder



**Assembly video**  
<http://q-r.to/05zT>



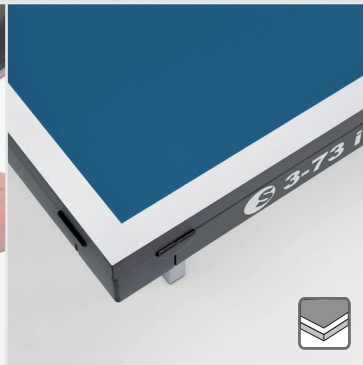

**S 3-72 i**  
**S 3-73 i**

**Service:** Assembly instructions and information for users are included in delivery. Instruction for use, as well as the service code number (for technical questions or complaints) are to be found on the underside of the table top.

**Warranty claim:** 2 years (according to legal regulations).

**Security advice:** The table tennis table has to be placed on level ground and should be secured against rolling away or tipping over.



**Field of use**

Indoors. For active leisure time. In playback-position for sole training, too.



**Tabletop**

3tecWOOD 19mm, coated several times, green or blue, metal frame 36mm.



**Net set**

Pilot-II-EN-stationary. Net: black. Net set can remain on the table in the playback- or in storage position, it also increases the stability of the table.



**Locking system**

SMS (Smart Manual System). Handle visible from all sides and in any position. Drawbar underneath the tabletop unlocks both of the safety devices simultaneously. Simple and automatic click-mechanism in storage and playing position of the table.



**Undercarriage**

Square-profile 25 x 25mm, window grey, powder-coated.



**Wheels**

4 double wheels Ø 125mm, 2 wheels are manoeuvrable, allow moving the table on rough ground.



**Special features**

Bat and ball holder on both sides of the table, for keeping 4 balls and 2 bats each.



**Assembly video**

Practical supplement to the assembly instruction. Step by step to the finished table tennis table - clearly explained in the video. Available via QR code. [Link: http://q-r.to/05zT](http://q-r.to/05zT)



**Dimensions**

Storage position: L=163cm (with net 180cm) x W=69cm x H=163cm  
Playing position: L=274cm x W (with net)=180cm x H=76cm  
(Tabletop in accordance with international dimensions)



**Packaging**

Type A (single carton)  
H=158cm x L=142cm x W=12cm



**Weight**

Table tennis table 72,5 kg, with packaging 78 kg



S 3-73 e

10 years warranty<sup>1)</sup>

<sup>1)</sup>for outdoor melamine resin boards according to our warranty terms



S 3-72 e



S3 LINE



Quality made in Germany

Art.-Nr. 234.DEFG/Hi

Delivery will be made without bats and balls.  
Subject to technical alterations.



## S 3-72 e / S 3-73 e



**Field of use**  
Outdoors



**Tabletop**  
\*\* Melamine resin board 5mm, metal frame 36mm



**Net set**  
Pilot-II-EN-stationary



**Undercarriage**  
Compact (type 4b), window grey



**Wheels**  
4 double wheels Ø 125mm,  
2 wheels are manoeuvrable



**Locking system**  
SMS (Smart Manual System)



**Special features**  
Bat and ball holder



**Assembly video**  
[http://youtu.be/7et3P9\\_ftzU](http://youtu.be/7et3P9_ftzU)

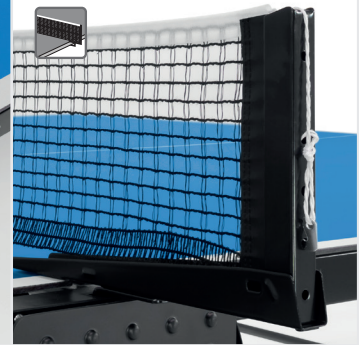
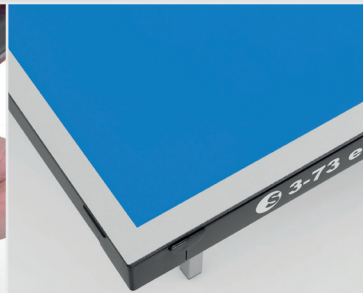
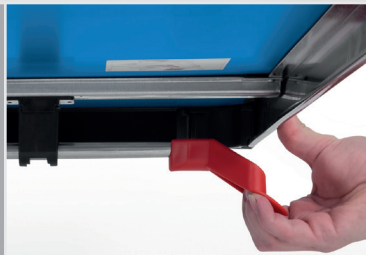

**S 3-72 e**  
**S 3-73 e**

**Service:** Assembly instructions and information for users are included in delivery. Instruction for use, as well as the service code number (for technical questions or complaints) are to be found on the underside of the table top.

**Warranty claim:** 2 years (according to legal regulations).

**Security advice:** The table tennis table has to be placed on level ground and should be secured against rolling away or tipping over.



**Field of use**

Outdoors. For active leisure time. In playback-position for sole training, too.



**Tabletop**

\*\* Melamine resin board 5mm, green or blue, limited impact-resistant, resistant against dampness, metal frame 36mm.



**Net set**

Pilot-II-EN-stationary. Net: black. Net set can remain on the table in the playback- or in storage position, it also increases the stability of the table.



**Locking system**

SMS (Smart Manual System). Handle visible from all sides and in any position. Drawbar underneath the tabletop unlocks both of the safety devices simultaneously. Simple and automatic click-mechanism in storage and playing position of the table.



**Undercarriage**

Square-profile 25 x 25mm, window grey, powder-coated.



**Wheels**

4 double wheels Ø 125mm, 2 wheels are manoeuvrable, allow moving the table on rough ground.



**Special features**

Bat and ball holder on both sides of the table, for keeping 4 balls and 2 bats each.



**Assembly video**

Practical supplement to the assembly instruction. Step by step to the finished table tennis table - clearly explained in the video. Available via QR code. [Link: http://q-r.to/05zb](http://q-r.to/05zb)



**Dimensions**

Storage position: L=163cm (with net 180cm) x W=69cm x H=163cm  
Playing position: L=274cm x W (with net)=180cm x H=76cm  
(Tabletop in accordance with international dimensions)



**Packaging**

Type A (single carton)  
H=158cm x L=142cm x W=10cm



**Weight**

Table tennis table 54,5 kg,  
with packaging 60 kg





S 3-80 i



S 3-87 i



S3 LINE



Class C  
EN 14468-1



Quality  
made in  
Germany

Art.-Nr. 208.DEFG/Hi

Delivery will be made  
without bats and balls.  
Subject to technical alterations.



S 3-80 i / S 3-87 i



**Field of use**  
Indoors



**Tabletop**  
3tecWOOD 19mm, metal frame 36mm



**Net set**  
Primus-EN-stationary-compact



**Undercarriage**  
Compact (type 4b), white



**Wheels**  
4 double wheels Ø 128mm,  
all wheels are manoeuvrable



**Locking system**  
SMS (Smart Manual System)



**Special features**  
Bat and ball holder, height adjuster



**Assembly video**  
<http://q-r.to/05zg>

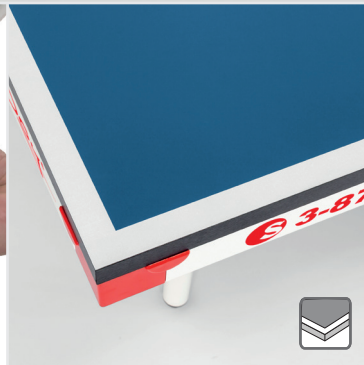
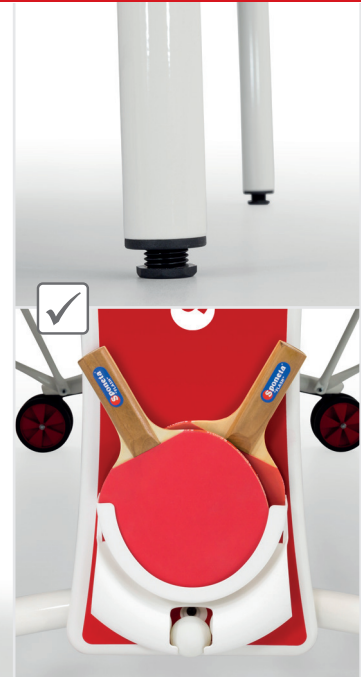

**S 3-80 i**  
**S 3-87 i**

**Service:** Assembly instructions and information for users are included in delivery. Instruction for use, as well as the service code number (for technical questions or complaints) are to be found on the underside of the tabletop.

**Warranty claim:** 2 years (according to legal regulations).

**Security advice:** The table tennis table has to be placed on level ground and should be secured against rolling away or tipping over.



**Field of use**

Indoors. The table tennis table for individuals with a sense of sporty design. In playback-position for sole training, too.



**Tabletop**

3tecWOOD 19mm, coated several times, grey, green or blue, metal frame 36mm.



**Net set**

Primus-EN-stationary-compact. Net: black, with stretching cord. Net set remains on the table in the playback- or in storage position.



**Locking system**

SMS (Smart Manual System). Handle visible from all sides and in any position. Drawbar underneath the tabletop unlocks both of the safety devices simultaneously. Simple and automatic click-mechanism in storage and playing position of the table.



**Undercarriage**

Tubular-profile 40mm, white, powder-coated.



**Wheels**

4 double wheels Ø 128mm, all wheels are manoeuvrable, allow moving the table on rough ground.



**Special features**

Bat and ball holder for keeping 5 balls and 2 bats. Balance of different standing positions and unevenness up to 30mm through height adjustment on the outer legs.



**Assembly video**

Practical supplement to the assembly instruction. Step by step to the finished table tennis table - clearly explained in the video. Available via QR code. [Link: http://q-r.to/05zg](http://q-r.to/05zg)



**Dimensions**

Storage position: L=165cm (with net 185cm) x W=73cm x H=159cm  
Playing position: L=274cm x W (with net)=185cm x H=76cm  
(Tabletop in accordance with international dimensions)



**Packaging**

Type A (single carton)  
H=158cm x L=142cm x W=15,5cm



**Weight**

Table tennis table 76,5 kg,  
with packaging 82 kg



S 3-80 e

10 years warranty<sup>1)</sup>

<sup>1)</sup>for outdoor melamine resin boards according to our warranty terms



S 3-87 e



S3 LINE



Quality  
made in  
Germany

Art.-Nr. 209.DEFG/HI

Delivery will be made without bats and balls.  
Subject to technical alterations.



S 3-80 e / S 3-87 e



**Field of use**  
Outdoors



**Tabletop**  
\*\* Melamine resin board 5mm, metal frame 36mm



**Net set**  
Primus-EN-stationary-compact



**Undercarriage**  
Compact (type 4b), white



**Wheels**  
4 double wheels Ø 128mm,  
all wheels are manoeuvrable



**Locking system**  
SMS (Smart Manual System)



**Special features**  
Bat and ball holder, height adjuster



**Assembly video**  
<http://q-r.to/0601>



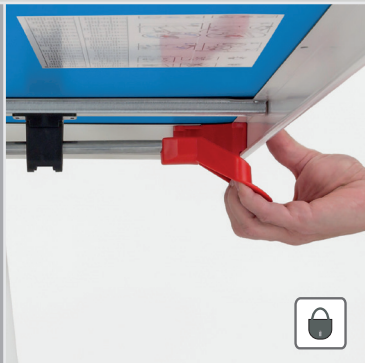

**S 3-80 e**  
**S 3-87 e**

**Service:** Assembly instructions and information for users are included in delivery. Instruction for use, as well as the service code number (for technical questions or complaints) are to be found on the underside of the table top.

**Warranty claim:** 2 years (according to legal regulations).

**Security advice:** The table tennis table has to be placed on level ground and should be secured against rolling away or tipping over.



**Field of use**

Outdoors. The table tennis table for individuals with a sense of sporty design. In playback-position for sole training, too.



**Tabletop**

\*\* Melamine resin board 5mm, grey, green or blue, limited impact-resistant, resistant against dampness, metal frame 36mm.



**Net set**

Primus-EN-stationary-compact. Net: black, with stretching cord. Net set remains on the table in the playback- or in storage position.



**Locking system**

SMS (Smart Manual System). Handle visible from all sides and in any position. Drawbar underneath the tabletop unlocks both of the safety devices simultaneously. Simple and automatic click-mechanism in storage and playing position of the table.



**Undercarriage**

Tubular-profile 40mm, white, powder-coated.



**Wheels**

4 double wheels Ø 128mm, all wheels are manoeuvrable, allow moving the table on rough ground.



**Special features**

Bat and ball holder for keeping 5 balls and 2 bats. Balance of different standing positions and unevenness up to 30mm through height adjustment on the outer legs.



**Assembly video**

Practical supplement to the assembly instruction. Step by step to the finished table tennis table - clearly explained in the video. Available via QR code. [Link: http://q-r.to/0601](http://q-r.to/0601)



**Dimensions**

Storage position: L=165cm (with net 185cm) x W=73cm x H=159cm  
Playing position: L=274cm x W (with net)=185cm x H=76cm  
(Tabletop in accordance with international dimensions)



**Packaging**

Type A (single carton)  
H=158cm x L=142cm x W=14cm



**Weight**

Table tennis table 59,5 kg,  
with packaging 65 kg



S 3-80 i



S 3-87 i



S3 LINE



Quality  
made in  
Germany

Art.-Nr. 208.DEFG/Hi

Delivery will be made  
without bats and balls.  
Subject to technical alterations.



S 3-80 i / S 3-87 i



**Field of use**  
Indoors



**Tabletop**  
3tecWOOD 19mm, metal frame 36mm



**Net set**  
Primus-EN-stationary-compact



**Undercarriage**  
Compact (type 4b), black



**Wheels**  
4 double wheels Ø 128mm,  
all wheels are manoeuvrable



**Locking system**  
SMS (Smart Manual System)



**Special features**  
Bat and ball holder, height adjuster



**Assembly video**  
<http://q-r.to/05zg>



**S 3-80 i**  
**S 3-87 i**

**Service:** Assembly instructions and information for users are included in delivery. Instruction for use, as well as the service code number (for technical questions or complaints) are to be found on the underside of the table top.

**Warranty claim:** 2 years (according to legal regulations).

**Security advice:** The table tennis table has to be placed on level ground and should be secured against rolling away or tipping over.



**Field of use**

Indoors. The table tennis table for individuals with a sense of sporty design. In playback-position for sole training, too.



**Tabletop**

3tecWOOD 19mm, coated several times, grey, green or blue, metal frame 36mm.



**Net set**

Primus-EN-stationary-compact. Net: black, with stretching cord. Net set remains on the table in the playback- or in storage position.



**Locking system**

SMS (Smart Manual System). Handle visible from all sides and in any position. Drawbar underneath the tabletop unlocks both of the safety devices simultaneously. Simple and automatic click-mechanism in storage and playing position of the table.



**Undercarriage**

Tubular-profile 40mm, black, powder-coated.



**Wheels**

4 double wheels Ø 128mm, all wheels are manoeuvrable, allow moving the table on rough ground.



**Special features**

Bat and ball holder for keeping 5 balls and 2 bats. Balance of different standing positions and unevenness up to 30mm through height adjustment on the outer legs.



**Assembly video**

Practical supplement to the assembly instruction. Step by step to the finished table tennis table - clearly explained in the video. Available via QR code. [Link: http://q-r.to/05zg](http://q-r.to/05zg)



**Dimensions**

Storage position: L=165cm (with net 185cm) x W=73cm x H=159cm  
Playing position: L=274cm x W (with net)=185cm x H=76cm  
(Tabletop in accordance with international dimensions)



**Packaging**

Type A (single carton)  
H=158cm x L=142cm x W=15,5cm



**Weight**

Table tennis table 76,5 kg, with packaging 82 kg





S 3-80 e

10 years warranty<sup>1)</sup>

<sup>1)</sup>for outdoor melamine resin boards according to our warranty terms



S 3-87 e



S3 LINE



Class C  
EN 14468-1



Quality  
made in  
Germany

Art.-Nr. 209.DEFG/HI

Delivery will be made without bats and balls.  
Subject to technical alterations.



S 3-80 e / S 3-87 e



**Field of use**  
Outdoors



**Tabletop**  
\*\* Melamine resin board 5mm, metal frame 36mm



**Net set**  
Primus-EN-stationary-compact



**Undercarriage**  
Compact (type 4b), black



**Wheels**  
4 double wheels Ø 128mm,  
all wheels are manoeuvrable



**Locking system**  
SMS (Smart Manual System)



**Special features**  
Bat and ball holder, height adjuster



**Assembly video**  
<http://q-r.to/0601>

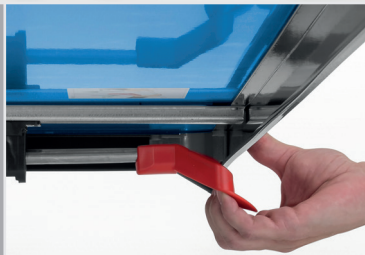

**S 3-80 e**  
**S 3-87 e**

**Service:** Assembly instructions and information for users are included in delivery. Instruction for use, as well as the service code number (for technical questions or complaints) are to be found on the underside of the tabletop.

**Warranty claim:** 2 years (according to legal regulations).

**Security advice:** The table tennis table has to be placed on level ground and should be secured against rolling away or tipping over.



**Field of use**

Outdoors. The table tennis table for individuals with a sense of sporty design. In playback-position for sole training, too.



**Tabletop**

\*\* Melamine resin board 5mm, grey, green or blue, limited impact-resistant, resistant against dampness, metal frame 36mm.



**Net set**

Primus-EN-stationary-compact. Net: black, with stretching cord. Net set remains on the table in the playback- or in storage position.



**Locking system**

SMS (Smart Manual System). Handle visible from all sides and in any position. Drawbar underneath the tabletop unlocks both of the safety devices simultaneously. Simple and automatic click-mechanism in storage and playing position of the table.



**Undercarriage**

Tubular-profile 40mm, white, powder-coated.



**Wheels**

4 double wheels Ø 128mm, all wheels are manoeuvrable, allow moving the table on rough ground.



**Special features**

Bat and ball holder for keeping 5 balls and 2 bats. Balance of different standing positions and unevenness up to 30mm through height adjustment on the outer legs.



**Assembly video**

Practical supplement to the assembly instruction. Step by step to the finished table tennis table - clearly explained in the video. Available via QR code. [Link: http://q-r.to/0601](http://q-r.to/0601)



**Dimensions**

Storage position: L=165cm (with net 185cm) x W=73cm x H=159cm  
Playing position: L=274cm x W (with net)=185cm x H=76cm  
(Tabletop in accordance with international dimensions)



**Packaging**

Type A (single carton)  
H=158cm x L=142cm x W=14cm



**Weight**

Table tennis table 59,5 kg,  
with packaging 68 kg





S 4-70 i



S 4-72 i



S 4-73 i



S4 LINE



Quality  
made in  
Germany

Art.-Nr. 204.DEFG/Hi

Delivery will be made  
without bats and balls.  
Subject to technical alterations.



## S 4-70 i / S 4-72 i / S 4-73 i



**Field of use**  
Indoors



**Tabletop**  
3tecWOOD 19mm, metal frame 50mm



**Net set**  
Perfect-II-EN-stationary-compact, height-adjustable



**Undercarriage**  
Compact (type 4b), black grey matt



**Wheels**  
4 double wheels Ø 128mm,  
with rubber tread, all wheels are manoeuvrable



**Locking system**  
SMS (Smart Manual System)



**Special features**  
Bat and ball holder, height adjuster



**Assembly video**  
<http://q-r.to/0609>



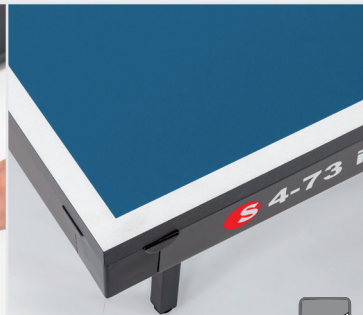
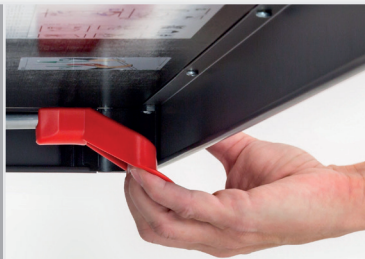
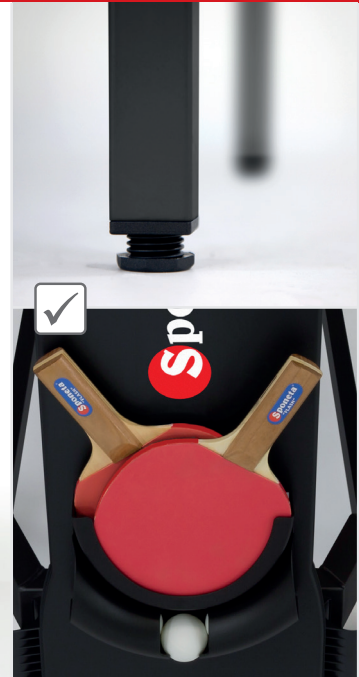

**S 4-70 i**  
**S 4-72 i**  
**S 4-73 i**

**Service:** Assembly instructions and information for users are included in delivery. Instruction for use, as well as the service code number (for technical questions or complaints) are to be found on the underside of the table top.

**Warranty claim:** 2 years (according to legal regulations).

**Security advice:** The table tennis table has to be placed on level ground and should be secured against rolling away or tipping over.



**Field of use**

Indoors. For amateurs with high demands. In playback-position for sole training, too.



**Tabletop**

3tecWOOD 19mm, coated several times, grey, green or blue, metal frame 50mm.



**Net set**

Perfect-II-EN-stationary-compact. Net: black. Net set can remain on the table in the playing-, playback- or in storage position, it also increases the stability of the table.



**Locking system**

SMS (Smart Manual System). Handle visible from all sides and in any position. Drawbar underneath the tabletop unlocks both of the safety devices simultaneously. Simple and automatic click-mechanism in storage and playing position of the table.



**Undercarriage**

Square-profile 30 x 30mm, black grey matt, powder-coated.



**Wheels**

4 double wheels Ø 128mm with rubber tread, all wheels are manoeuvrable, allow moving the table on rough ground.



**Special features**

Bat and ball holder for keeping 9 balls and 2 bats. Balance of different standing positions and unevenness up to 30mm through height adjustment on the outer legs.



**Assembly video**

Practical supplement to the assembly instruction. Step by step to the finished table tennis table - clearly explained in the video. Available via QR code. [Link: http://q-r.to/0609](http://q-r.to/0609)



**Dimensions**

Storage position: L=164cm (with net 187cm) x W=72cm x H=156cm  
Playing position: L=274cm x W (with net)=187cm x H=76cm  
(Tabletop in accordance with international dimensions)



**Packaging**

Type A (single carton)  
H=158cm x L=142cm x W=16cm



**Weight**

Table tennis table 77 kg,  
with packaging 82,5 kg



S 4-70 e



S 4-72 e



S 4-73 e



S4 LINE



Quality  
made in  
Germany

Art.-Nr. 212.DEFG/HI

Delivery will be made  
without bats and balls.  
Subject to technical alterations.

10 years  
warranty<sup>1)</sup>

<sup>1)</sup>for outdoor  
melamine  
resin boards  
according to  
our warranty  
terms



## S 4-70 e / S 4-72 e / S 4-73 e



**Field of use**  
Outdoors



**Tabletop**  
\*\* Melamine resin board 5mm, metal frame 50mm



**Net set**  
Perfect-II-EN-stationary-compact, height-adjustable



**Undercarriage**  
Compact (type 4b), black grey matt



**Wheels**  
4 double wheels Ø 128mm,  
with rubber tread, all wheels are manoeuvrable



**Locking system**  
SMS (Smart Manual System)



**Special features**  
Bat and ball holder, height adjuster



**Assembly video**  
<http://q-r.to/060E>



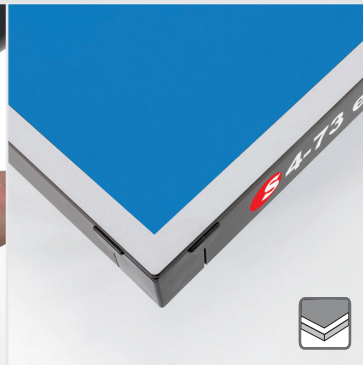

**Service:** Assembly instructions and information for users are included in delivery. Instruction for use, as well as the service code number (for technical questions or complaints) are to be found on the underside of the table top.

**Warranty claim:** 2 years (according to legal regulations).

**Security advice:** The table tennis table has to be placed on level ground and should be secured against rolling away or tipping over.



**S 4-70 e**  
**S 4-72 e**  
**S 4-73 e**



**Field of use**  
Outdoors. For amateurs with high demands. In playback-position for sole training, too.



**Tabletop**  
\*\* Melamine resin board, grey, green or blue, limited impact-resistant, resistant against dampness, metal frame 50mm.



**Net set**  
Perfect-II-EN-stationary-compact. Net: black. Net set can remain on the table in the playing-, playback- or in storage position, it also increases the stability of the table.



**Locking system**  
SMS (Smart Manual System). Handle visible from all sides and in any position. Drawbar underneath the tabletop unlocks both of the safety devices simultaneously. Simple and automatic click-mechanism in storage and playing position of the table.



**Undercarriage**  
Square-profile 30 x 30mm, black grey matt, powder-coated.



**Wheels**  
4 double wheels Ø 128mm with rubber tread, all wheels are manoeuvrable, allow moving the table on rough ground.



**Special features**  
Bat and ball holder for keeping 9 balls and 2 bats. Balance of different standing positions and unevenness up to 30mm through height adjustment on the outer legs.



**Assembly video**  
Practical supplement to the assembly instruction. Step by step to the finished table tennis table - clearly explained in the video. Available via QR code. [Link: http://q-r.to/060E](http://q-r.to/060E)



**Dimensions**  
Storage position: L=164cm (with net 187cm) x W=72cm x H=156cm  
Playing position: L=274cm x W (with net)=187cm x H=76cm  
(Tabletop in accordance with international dimensions)



**Packaging**  
Type A (single carton)  
H=158cm x L=142cm x W=13,5cm



**Weight**  
Table tennis table 59,5 kg, with packaging 65 kg





S 5-70 i



S 5-72 i



S 5-73 i



S5 LINE



Quality  
made in  
Germany

Art.-Nr. 205.DEFG/Hi

Delivery will be made  
without bats and balls.  
Subject to technical alterations.



## S 5-70 i / S 5-72 i / S 5-73 i



**Field of use**  
Indoors



**Tabletop**  
3tecWOOD 22mm, metal frame 50mm



**Net set**  
Perfect-II-EN-stationary-compact, height-adjustable,  
with stretching cord



**Undercarriage**  
Compact (type 4b), colour: white aluminium



**Wheels**

4 wheels Ø 100mm, with rubber tread, all wheels  
are manoeuvrable, 2 of them are lockable



**Locking system**

SMS (Smart Manual System)



**Special features**

Bat and ball holder, height adjuster



**Assembly video**

<http://q-r.to/0601>

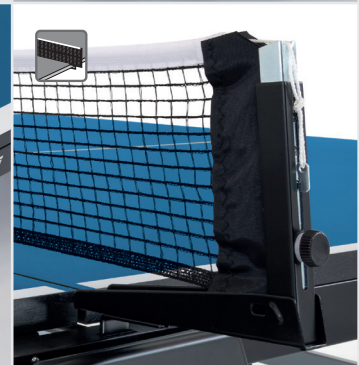
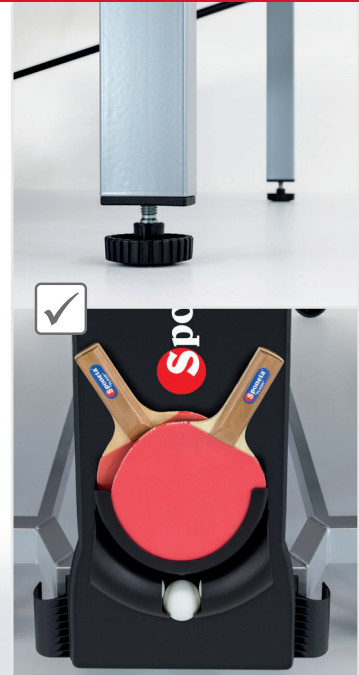

**S 5-70 i**  
**S 5-72 i**  
**S 5-73 i**

**Service:** Assembly instructions and information for users are included in delivery. Instruction for use, as well as the service code number (for technical questions or complaints) are to be found on the underside of the table top.

**Warranty claim:** 2 years (according to legal regulations).

**Security advice:** The table tennis table has to be placed on level ground and should be secured against rolling away or tipping over.



**Field of use**

Indoors. For sports in schools and clubs. In playback-position for sole training, too.



**Tabletop**

3tecWOOD 22mm, coated several times with special coating, grey, green or blue, more stability through a metal frame 50mm.



**Net set**

Perfect-II-EN-stationary-compact. Net: black. Net set can remain on the table in the playing-, playback- or in storage position, it also increases the stability of the table.



**Locking system**

SMS (Smart Manual System). Handle visible from all sides and in any position. Drawbar underneath the tabletop unlocks both of the safety devices simultaneously. Simple and automatic click-mechanism in storage and playing position of the table.



**Undercarriage**

Square-profile 50 x 30mm, white aluminium, powder-coated.



**Wheels**

4 wheels Ø 100mm with rubber tread, all wheels are manoeuvrable, 2 of them are lockable.



**Special features**

Bat and ball holder for keeping 9 balls and 2 bats. Balance of different standing positions and unevenness up to 30mm through height adjustment on the outer legs.



**Assembly video**

Practical supplement to the assembly instruction. Step by step to the finished table tennis table - clearly explained in the video. Available via QR code. [Link: http://q-r.to/0601](http://q-r.to/0601)



**Dimensions**

Storage position: L=164cm (with net 187cm) x W=72cm x H=156cm  
Playing position: L=274cm x W (with net)=187cm x H=76cm  
(Tabletop in accordance with international dimensions)



**Packaging**

Type A (single carton)  
H=158cm x L=142cm x W=16cm



**Weight**

Table tennis table 91 kg,  
with packaging 96,5 kg





S 5-70 e



S 5-72 e



S 5-73 e



S5 LINE



Quality  
made in  
Germany

Art.-Nr. 213.DEFG/Hi

Delivery will be made  
without bats and balls.  
Subject to technical alterations.

10 years  
warranty<sup>1)</sup>

<sup>1)</sup>for outdoor  
melamine  
resin boards  
according to  
our warranty  
terms



## S 5-70 e / S 5-72 e / S 5-73 e



**Field of use**  
Outdoors



**Tabletop**  
\*\* Melamine resin board 6mm, metal frame 50mm



**Net set**  
Perfect-II-EN-stationary-compact, height-adjustable,  
with stretching cord



**Undercarriage**  
Compact (type 4b), colour: white aluminium



**Wheels**  
4 double wheels Ø 128mm,  
with rubber tread, all wheels are manoeuvrable



**Locking system**  
SMS (Smart Manual System)



**Special features**  
Bat and ball holder, height adjuster



**Assembly video**  
<http://q-r.to/05zV>



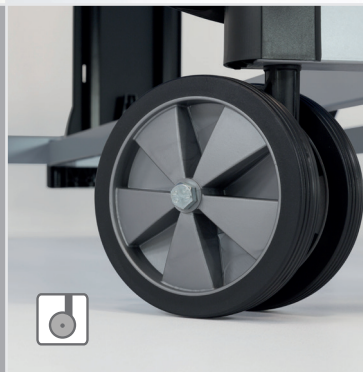
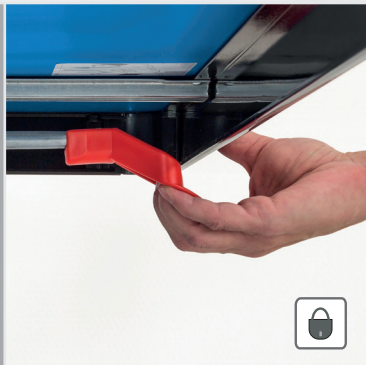

**S 5-70 e**  
**S 5-72 e**  
**S 5-73 e**

**Service:** Assembly instructions and information for users are included in delivery. Instruction for use, as well as the service code number (for technical questions or complaints) are to be found on the underside of the table top.

**Warranty claim:** 2 years (according to legal regulations).

**Security advice:** The table tennis table has to be placed on level ground and should be secured against rolling away or tipping over.



**Field of use**

Outdoors. For sports in schools and clubs. In playback-position for sole training, too.



**Tabletop**

\*\* Melamine resin board, grey, green or blue, limited impact-resistant, resistant against dampness, metal frame 50mm.



**Net set**

Perfect-II-EN-stationary-compact. Net: black. Net set can remain on the table in the playing-, playback- or in storage position, it also increases the stability of the table.



**Locking system**

SMS (Smart Manual System). Handle visible from all sides and in any position. Drawbar underneath the tabletop unlocks both of the safety devices simultaneously. Simple and automatic click-mechanism in storage and playing position of the table.



**Undercarriage**

Square-profile 50 x 30mm, white aluminium, powder-coated.



**Wheels**

4 double wheels Ø 128mm with rubber tread, all wheels are manoeuvrable. Allow moving the table on rough ground.



**Special features**

Bat and ball holder for keeping 9 balls and 2 bats. Balance of different standing positions and unevenness up to 30mm through height adjustment on the outer legs.



**Assembly video**

Practical supplement to the assembly instruction. Step by step to the finished table tennis table - clearly explained in the video. Available via QR code. [Link: http://q-r.to/05zV](http://q-r.to/05zV)



**Dimensions**

Storage position: L=164cm (with net 187cm) x W=72cm x H=156cm  
Playing position: L=274cm x W (with net)=187cm x H=76cm  
(Tabletop in accordance with international dimensions)



**Packaging**

Type A (single carton)  
H=158cm x L=142cm x W=13,5cm



**Weight**

Table tennis table 70 kg,  
with packaging 75,5 kg



S 6-13 i



S 6-12 i



S6 LINE



Art.-Nr. 226.DEFG/HI

Delivery will be made without bats and balls.  
Subject to technical alterations.



S 6-12 i / S 6-13 i



**Field of use**  
Indoors



**Tabletop**  
3tecWOOD 22mm, metal frame A 40mm



**Net set**  
Classic (ITTF-approved)



**Undercarriage**  
semi-compact (type 3), light grey



**Wheels**

4 wheels Ø 100mm, with rubber tread each tabletop, all wheels are manoeuvrable, 2 of them are lockable



**Locking system**

Handle system



**Special features**

Height adjuster, space-saving storage possibilities, tabletop connector



**Assembly video**

<http://q-r.to/05zM>



**Service:** Assembly instructions and information for users are included in delivery. Instruction for use, as well as the service code number (for technical questions or complaints) are to be found on the underside of the table top.

**Warranty claim:** 2 years (according to legal regulations).

**Security advice:** The table tennis table has to be placed on level ground and should be secured against rolling away or tipping over.



**S 6-12 i**  
**S 6-13 i**



**Field of use**

Indoors. The perfect training table. In playback-position for sole training, too.



**Tabletop**

3tecWOOD 22mm, coated several times with special coating, green or blue, more stability through a metal frame A 40mm.



**Net set**

Classic (ITTF-approved), net black. Height adjustable with adjusting screw, with stretching cord.



**Locking system**

Handle system. Metal handle underneath the tabletop unlocks both of the safety devices simultaneously. Simple and automatic click-mechanism in storage and playing position of the table.



**Undercarriage**

Square-profile 30 x 30mm/40 x 40mm, light grey, powder-coated.



**Wheels**

4 wheels Ø 100mm with rubber tread each tabletop, all wheels are manoeuvrable, 2 of them are lockable.



**Special features**

Balance of different standing positions and unevenness up to 30mm through height adjustment on the outer legs. When placing the table in storage position, several tables can be placed into each other. High stability through tabletop connector.



**Assembly video**

Practical supplement to the assembly instruction. Step by step to the finished table tennis table - clearly explained in the video. Available via QR code. [Link: http://q-r.to/05zM](http://q-r.to/05zM)



**Dimensions**

Storage position: L=158cm x W=70cm x H=172cm  
Playing position: L=274cm x W (with net)=185cm x H=76cm  
(Tabletop in accordance with international dimensions)



**Packaging**

Type B (double carton)  
H=158cm x L=142cm x W=20cm



**Weight**

Table tennis table 95,5 kg, with packaging 106,5 kg





S 6-53 i

*Quick-cross bars*  
only 15min of assembly time



S 6-52 i



S6 LINE



Quality  
made in  
Germany

Art.-Nr. 228.DEFG/HI

Delivery will be made  
without bats and balls.  
Subject to technical alterations.



## S 6-52 i / S 6-53 i



**Field of use**  
Indoors



**Tabletop**  
3tecWOOD 22mm, metal frame A 60mm



**Net set**  
Classic (ITTF-approved)



**Undercarriage**  
semi-compact (type 3), light grey



### Wheels

4 wheels Ø 125mm, with rubber tread each tabletop, all wheels are manoeuvrable, 2 of them are lockable



**Locking system**  
Handle system



### Special features

Height adjuster, space-saving storage possibilities, tabletop connector



**Assembly video**  
<http://q-r.to/05zx>

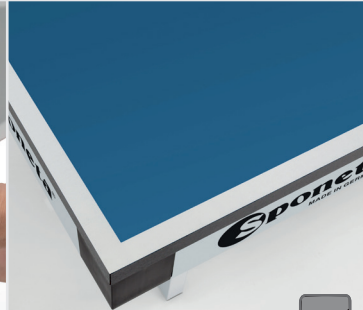
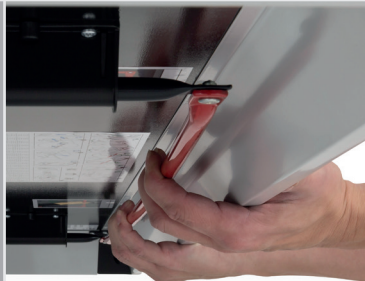

**Service:** Assembly instructions and information for users are included in delivery. Instruction for use, as well as the service code number (for technical questions or complaints) are to be found on the underside of the table top.

**Warranty claim:** 2 years (according to legal regulations).

**Security advice:** The table tennis table has to be placed on level ground and should be secured against rolling away or tipping over.

**S 6-52 i**  
**S 6-53 i**



**Field of use**

Indoors. The perfect training table. In play-back-position for sole training, too.



**Tabletop**

3tecWOOD 22mm, coated several times with special coating, green or blue, more stability through a metal frame A 60mm.



**Net set**

Classic (ITTF-approved), net black. Height adjustable with adjusting screw, with stretching cord.



**Locking system**

Handle system. Metal handle underneath the tabletop unlocks both of the safety devices simultaneously. Simple and automatic click-mechanism in storage and playing position of the table.



**Undercarriage**

Square-profile 30 x 30mm/40 x 40mm, light grey, powder-coated.



**Wheels**

4 wheels Ø 125mm with rubber tread each tabletop, all wheels are manoeuvrable, 2 of them are lockable.



**Special features**

Balance of different standing positions and unevenness up to 30mm through height adjustment on the outer legs. When placing the table in storage position, several tables can be placed into each other. High stability through tabletop connector.



**Assembly video**

Practical supplement to the assembly instruction. Step by step to the finished table tennis table - clearly explained in the video. Available via QR code. [Link: http://q-r.to/05zx](http://q-r.to/05zx)



**Dimensions**

Storage position: L=158cm x W=71cm x H=164cm  
Playing position: L=274cm x W (with net)=185cm x H=76cm  
(Tabletop in accordance with international dimensions)



**Packaging**

Type B (double carton)  
H=158cm x L=142cm x W=12cm



**Weight**

Table tennis table 101 kg, with packaging 112 kg



S 6-67 e

10 years warranty<sup>1)</sup>

**Durable.  
Robust.  
Weatherproof.**

**THE alternative  
to concrete  
table.**

<sup>1)</sup>for outdoor melamine resin boards according to our warranty terms



S 6-66 e

**S6 LINE**



**Quality  
made in  
Germany**

**Art.-Nr. 239.DEFG/HI**

Delivery will be made without bats and balls.  
Subject to technical alterations.



## S 6-66 e / S 6-67 e



**Field of use**  
Outdoors



**Tabletop**  
\*\* Melamine resin board 10mm, metal frame  
50 x 20mm, massive substructure



**Net set**  
Metal net 2mm



**Undercarriage**  
Standard (type 1), light grey



**Special features**  
Net and metal construction galvanised,  
bottom attachment plate made of stainless steel



**Assembly video**  
<http://q-r.to/060N>



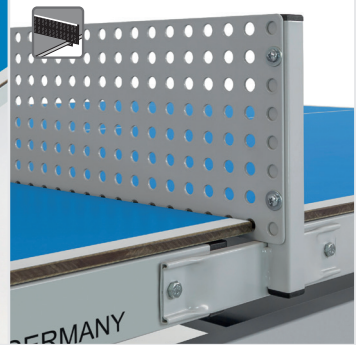
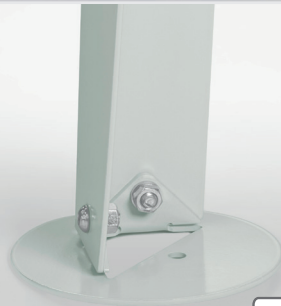

**S 6-66 e**  
**S 6-67 e**

**Service:** Assembly instructions and information for users are included in delivery. Instruction for use, as well as the service code number (for technical questions or complaints) are to be found on the underside of the table top.

**Warranty claim:** 2 years (according to legal regulations).

**Security advice:** The table tennis table has to be placed on level ground and should be secured against rolling away or tipping over.



**Field of use**

Outdoors. To be used throughout the year.



**Tabletop**

\*\* Melamine resin board 10mm, green or blue, limited impact-resistant against dampness, double strengthening by the frame 50 x 20mm and additional cross section 50 x 20mm.



**Net set**

Metal net made of 2mm sheet steel, galvanised and varnished.



**Locking**

Solid hold through anchoring on the standing area.



**Undercarriage**

Galvanised sheet, light grey, powder-coated.



**Special features**

The best possible alternative to a table tennis table made of concrete: Perfect playing conditions, stable underconstruction, very reasonable price.



**Assembly video**

Practical supplement to the assembly instruction. Step by step to the finished table tennis table - clearly explained in the video. Available via QR code. [Link: http://q-r.to/060N](http://q-r.to/060N)



**Dimensions**

Playing position: L=274cm x W (with net)=159cm x h=76cm (tabletop in accordance with international dimensions)



**Packaging**

Type A (single carton)  
H=158cm x L=142cm x W=14cm



**Weight**

Table tennis table 112,5 kg, with packaging 118 kg



S 6-80 e



S 6-86 e



S 6-87 e

10 years warranty<sup>1)</sup>

**Durable.  
Robust.  
Weatherproof.**

**THE** alternative  
to concrete  
table.

<sup>1)</sup>for outdoor melamine resin boards  
according to our warranty terms

S6 LINE



**Quality  
made in  
Germany**

Art.-Nr. 244.DEFG/HI

Technische Änderungen vorbehalten.  
Schläger und Bälle sind nicht  
im Lieferumfang enthalten.



## S 6-80 e / S 6-86 e / S 6-87 e



**Field of use**  
Outdoors



**Tabletop**  
\*\* Melamine resin board 10mm, metal frame  
50 x 20mm, massive substructure



**Net set**  
Metal net 2mm



**Undercarriage**  
Standard (type 1), chrome look



**Special features**  
Net and metal construction galvanised,  
bottom attachment plate made of stainless steel



**Assembly video**  
<http://q-r.to/badsir>

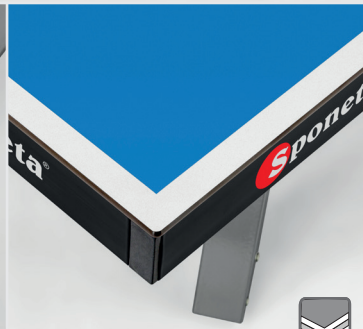
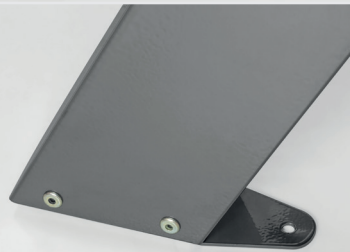

**S 6-80 e**  
**S 6-86 e**  
**S 6-87 e**

**Service:** Assembly instructions and information for users are included in delivery. Instruction for use, as well as the service code number (for technical questions or complaints) are to be found on the underside of the table top.

**Warranty claim:** 2 years (according to legal regulations).

**Security advice:** The table tennis table has to be placed on level ground and should be secured against rolling away or tipping over.



**Field of use**

Outdoors. To be used throughout the year.



**Tabletop**

\*\* Melamine resin board 10mm, grey, green or blue, limited impact-resistant against dampness, double strengthening by the frame 50 x 20mm and additional cross section 50 x 20mm



**Special features**

The best possible alternative to a table tennis table made of concrete: Perfect playing conditions, stable underconstruction, very reasonable price.



**Net set**

Metal net made of 2mm sheet steel, galvanised and varnished.



**Assembly video**

Practical supplement to the assembly instruction. Step by step to the finished table tennis table - clearly explained in the video. Available via QR code. [Link: http://q-r.to/badsir](http://q-r.to/badsir)



**Locking**

Solid hold through anchoring on the standing area.



**Dimensions**

Playing position: L=274cm x W (with net)=159cm x h=76cm (tabletop in accordance with international dimensions)



**Undercarriage**

Rectangle-tube-profile 100 x 60 / 70 x 40mm, galvanised sheet, colour: cromlook, powder-coated.



**Packaging**

Type B (double carton)  
H=158cm x L=142cm x W=23,5cm



**Weight**

Table tennis table 115 kg, with packaging 126 kg





S 7-13



Table tennis table + Net set  
ITTF approved



S 7-12



S7 LINE



Quality  
made in  
Germany

Art.-Nr. 218.DEFG/HI

Delivery will be made  
without bats and balls.  
Subject to technical alterations.



## S 7-12 / S 7-13



**Field of use**  
Indoors



**Tabletop**  
3tecWOOD 25mm, metal frame A 60mm



**Net set**  
Classic (ITTF-approved)



**Undercarriage**  
semi-compact (type 3), colour: grey aluminium



### Wheels

4 wheels Ø 100mm, with rubber tread each tabletop, all wheels are manoeuvrable, 2 of them are lockable



### Locking system

Handle system



### Special features

Height adjuster, tabletop connector, tabletop protector, ITTF-approved



### Assembly video

<http://q-r.to/baeW2h>

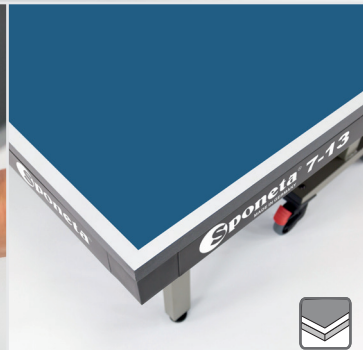

**S 7-12**  
**S 7-13**

**Service:** Assembly instructions and information for users are included in delivery. Instruction for use, as well as the service code number (for technical questions or complaints) are to be found on the underside of the table top.

**Warranty claim:** 2 years (according to legal regulations).

**Security advice:** The table tennis table has to be placed on level ground and should be secured against rolling away or tipping over.



**Field of use**

Indoors. For national and international tournaments. In playback-position for sole training, too.



**Tabletop**

3tecWOOD 25mm, coated several times with special varnish, green or blue. High stability through a metal frame A 60mm and additional profile A 60mm underneath the edge of the net.



**Net set**

Classic (ITTF-approved), net black. Height adjustable with adjusting screw, with stretching cord.



**Locking system**

Handle system. Metal handle underneath the tabletop unlocks both of the safety devices simultaneously. Simple and automatic click-mechanism in storage and playing position of the table.



**Undercarriage**

Rectangle-tube-profile 60 x 40mm, colour: grey aluminium, powder-coated.



**Wheels**

4 wheels Ø 100mm with rubber tread each tabletop, all wheels are manoeuvrable, 2 of them are lockable.



**Special features**

Balance of different standing positions and unevenness up to 30mm through height adjustment on the outer legs. When placing the table in storage position, several tables can be placed into each other. High stability through tabletop connector. ITTF approval.



**Assembly video**

Practical supplement to the assembly instruction. Step by step to the finished table tennis table - clearly explained in the video. Available via QR code. [Link: http://q-r.to/baeW2h](http://q-r.to/baeW2h)



**Dimensions**

Storage position: L=185cm x W=71cm x H=172cm  
Playing position: L=274cm x W (with net)=185cm x H=76cm  
(Tabletop in accordance with international dimensions)



**Packaging**

Type B (double carton)  
H=158cm x L=142cm x W=20cm



**Weight**

Table tennis table 111 kg,  
with packaging 122 kg



S 7-23



ready assembled



S 7-22



S7 LINE



Quality  
made in  
Germany

Art.-Nr. 225.DEFG/HI

Delivery will be made  
without bats and balls.  
Subject to technical alterations.



## S 7-22 / S 7-23



**Field of use**  
Indoors



**Tabletop**  
3tecWOOD 25mm, metal frame A 60mm



**Net set**  
Classic (ITTF-approved)



**Undercarriage**  
Standard (type 2), colour: grey aluminium



**Wheels**  
2 wheels Ø 128mm, with rubber tread  
each tabletop, for vertical transport



**Locking system**  
Clasp system



**Special features**  
Support legs ready assembled, tabletop connector,  
tabletop protector



**Assembly video**  
<http://q-r.to/060a>



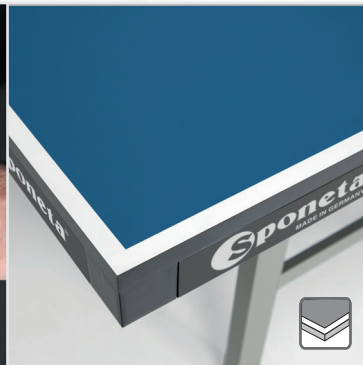

**S 7-22**  
**S 7-23**

**Service:** Assembly instructions and information for users are included in delivery. Instruction for use, as well as the service code number (for technical questions or complaints) are to be found on the underside of the table top.

**Warranty claim:** 2 years (according to legal regulations).

**Security advice:** The table tennis table has to be placed on level ground and should be secured against rolling away or tipping over.



**Field of use**

Indoors. For national and international tournaments.



**Tabletop**

3tecWOOD 25mm, coated several times with special varnish, green or blue. High stability through metal frame A 60mm and additional profile 50 x 20mm underneath the edge of the net.



**Net set**

Classic (ITTF-approved), net black. Height adjustable with adjusting screw, with stretching cord.



**Locking system**

Clasp system for fixation of stand legs in storage and in playing position.



**Undercarriage**

Rectangle-tube-profile 60 x 40mm, colour: grey aluminium, powder-coated.



**Wheels**

2 wheels Ø 128mm with rubber tread each tabletop for vertical transport.



**Special features**

Space-saving storage possibility. The table is ready assembled, except for the wheels. Increased stability in playing position by tabletop connector.



**Assembly video**

Practical supplement to the assembly instruction. Step by step to the finished table tennis table - clearly explained in the video. Available via QR code. [Link: http://q-r.to/060a](http://q-r.to/060a)



**Dimensions**

Storage position: L=152,5cm x W=17cm x H=143cm  
Playing position: L=274cm x W (with net)=185cm x H=76cm  
(Tabletop in accordance with international dimensions)



**Packaging**

Type B (double carton)  
H=158cm x L=142cm x W=20cm



**Weight**

Table tennis table 103 kg,  
with packaging 114 kg



S 7-63



Table tennis table  
ITTF approved



S 7-62



S7 LINE



Quality  
made in  
Germany

Art.-Nr. 258.DEFG/HI

Delivery will be made  
without bats and balls.  
Subject to technical alterations.



## S 7-62 / S 7-63



**Field of use**  
Indoors



**Tabletop**  
3tecWOOD 25mm, metal frame A 60mm



**Net set**  
Primus-II-EN-stationary-compact



**Undercarriage**  
Compact (type 4b),  
colour: grey aluminium and light grey



### Wheels

4 wheels Ø 100mm, with rubber tread, all wheels are manoeuvrable, 2 of them are lockable



### Locking system

Handle system



### Special features

Height adjuster



### Assembly video

<http://q-r.to/060j>

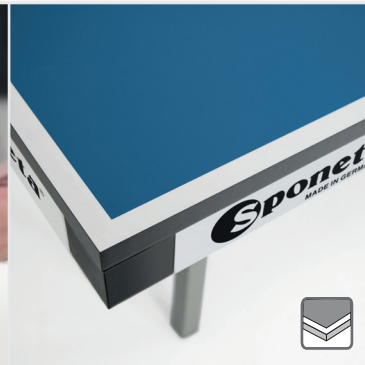

**S 7-62**  
**S 7-63**

**Service:** Assembly instructions and information for users are included in delivery. Instruction for use, as well as the service code number (for technical questions or complaints) are to be found on the underside of the table top.

**Warranty claim:** 2 years (according to legal regulations).

**Security advice:** The table tennis table has to be placed on level ground and should be secured against rolling away or tipping over.

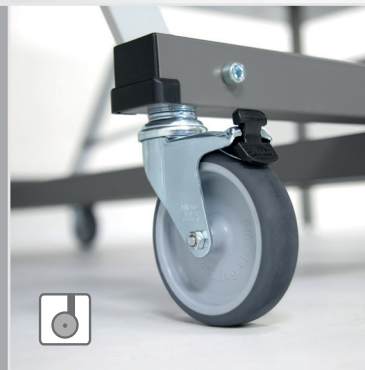

**Field of use**

Indoors. For national and international tournaments. In playback-position for sole training, too.



**Tabletop**

3tecWOOD 25mm, coated several times with special varnish, green or blue. High stability through metal frame A 60mm.



**Net set**

Primus-II-EN-stationary-compact, net black.



**Locking system**

Handle system. Metal handle underneath the tabletop unlocks both of the safety devices simultaneously. Simple and automatic click-mechanism in storage and playing position of the table.



**Undercarriage**

Rectangle-tube-profile 40 x 40mm, square-profile 40 x 10/20 x 10mm, colour: grey aluminium, powder-coated.



**Wheels**

4 wheels Ø 100mm with rubber tread, all wheels are manoeuvrable, 2 of them are lockable.



**Special features**

Balance of different standing positions and unevenness up to 30mm through height adjusters on the outer legs.



**Assembly video**

Practical supplement to the assembly instruction. Step by step to the finished table tennis table - clearly explained in the video. Available via QR code. [Link: http://q-r.to/060j](http://q-r.to/060j)



**Dimensions**

Storage position: L (with net)=186cm x W=71cm x H=155cm  
Playing position: L=274cm x W (with net)=186cm x H=76cm  
(Tabletop in accordance with international dimensions)



**Packaging**

Type B (double carton)  
H=158cm x L=142cm x W=20cm



**Weight**

Table tennis table 109 kg,  
with packaging 120 kg





S 8-37



Table tennis table + Net set  
ITTF approved



S 8-36



ready assembled



S8 LINE



Quality  
made in  
Germany

Art.-Nr. 250.DEFG/Hi

Delivery will be made  
without bats and balls.  
Subject to technical alterations.



## S 8-36 / S 8-37



**Field of use**  
Indoors



**Tabletop**  
3tecWOOD 25mm, metal frame A 60mm



**Net set**  
Classic (ITTF-approved)



**Undercarriage**  
Super-compact (type 5), anthracite metallic



### Wheels

4 wheels Ø 125mm, with rubber tread,  
all wheels are manoeuvrable



### Locking system

SMS (Smart Manual System)



### Special features

Height adjuster, tabletop protector, gas pressure  
springs for weight neutralisation, ITTF-approved



### Assembly video

<http://q-r.to/060n>

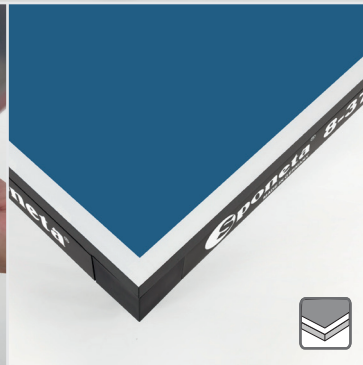
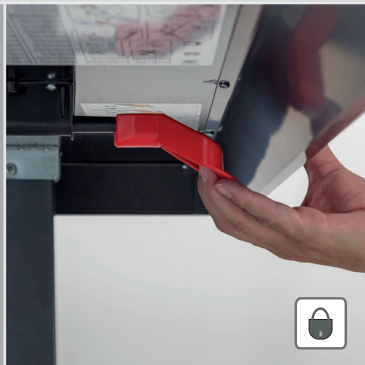
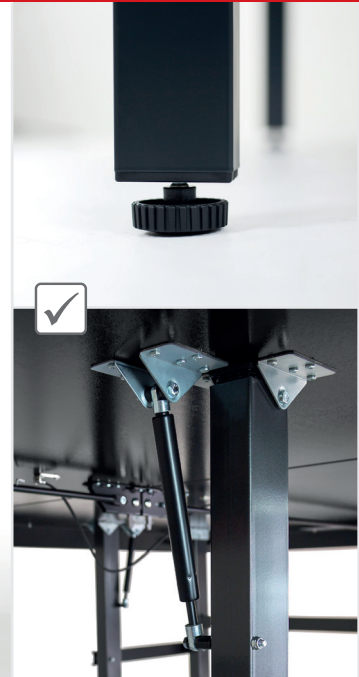

**S 8-36**  
**S 8-37**

**Service:** Assembly instructions and information for users are included in delivery. Instruction for use, as well as the service code number (for technical questions or complaints) are to be found on the underside of the table top.

**Warranty claim:** 2 years (according to legal regulations).

**Security advice:** The table tennis table has to be placed on level ground and should be secured against rolling away or tipping over.



**Field of use**

Indoors. High quality demands in an international scope.



**Tabletop**

3tecWOOD 25mm, coated several times with special varnish, green or blue. High stability through metal frame A 60mm.



**Net set**

Classic (ITTF-approved), net black, height adjustable, with stretching cord.



**Locking system**

SMS (Smart Manual System). Handle visible from all sides and in any position. Drawbar underneath the tabletop unlocks both of the safety devices simultaneously. Simple and automatic click-mechanism in storage and playing position of the table.



**Undercarriage**

Rectangle-tube-profile 60 x 40mm, anthracite metallic, powder-coated.



**Wheels**

4 wheels Ø 125mm with rubber tread, all wheels are manoeuvrable.



**Special features**

Balance of different standing positions and unevenness up to 30mm through height adjustment on the outer legs. Two gas pressure springs for weight neutralisation of the tabletops. When placing in storage position, several tables can be placed into each other. The table tennis table is ready assembled.



**Assembly video**

Practical supplement to the assembly instruction. Step by step to the finished table tennis table - clearly explained in the video. Available via QR code. [Link: http://q-r.to/060n](http://q-r.to/060n)



**Dimensions**

Storage position: L=152,5cm x W=55cm x H=161cm  
Playing position: L=274cm x W (with net)=185cm x H=76cm  
(Tabletop in accordance with international dimensions)



**Packaging**

Type E (single transport pallet)  
H=176cm x L=158cm x W=57cm



**Weight**

Table tennis table 109,5 kg,  
with packaging 135,5 kg



S 8-37 w



Table tennis table + Net set  
ITTF approved



S 8-36 w



wheelchair friendly



S8 LINE



Quality  
made in  
Germany

Art.-Nr. 256.DEFG/HI

Delivery will be made  
without bats and balls.  
Subject to technical alterations.



ready assembled



## S 8-36 w / S 8-37 w



**Field of use**  
Indoors



**Tabletop**  
3tecWOOD 25mm, metal frame A 60mm



**Net set**  
Classic (ITTF-approved)



**Undercarriage**  
Super-compact (type 5), anthracite metallic



### Wheels

4 wheels Ø 125mm, with rubber tread,  
all wheels are manoeuvrable,  
2 wheels are lockable



### Locking system

SMS (Smart Manual System)



### Special features

Height adjuster, tabletop protector,  
gas pressure springs for weight neutralisation,  
ITTF-approved, wheelchair friendly



### Assembly video

<http://q-r.to/060u>



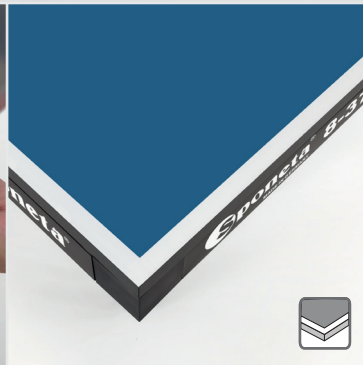
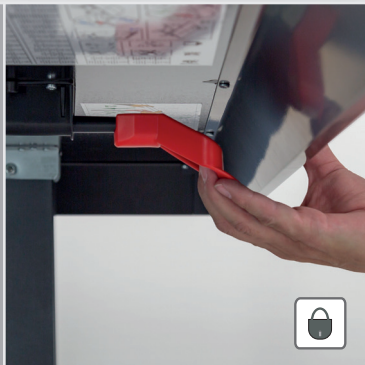

**S 8-36 W**  
**S 8-37 W**

**Service:** Assembly instructions and information for users are included in delivery. Instruction for use, as well as the service code number (for technical questions or complaints) are to be found on the underside of the table top.

**Warranty claim:** 2 years (according to legal regulations).

**Security advice:** The table tennis table has to be placed on level ground and should be secured against rolling away or tipping over.



**Field of use**

Indoors. High quality demands in an international scope.



**Tabletop**

3tecWOOD 25mm, coated several times with special varnish, green or blue. High stability through metal frame A 60mm.



**Net set**

Classic (ITTF-approved), net black, height adjustable, with stretching cord.



**Locking system**

SMS (Smart Manual System). Handle visible from all sides and in any position. Drawbar underneath the tabletop unlocks both of the safety devices simultaneously. Simple and automatic click-mechanism in storage and playing position of the table.



**Undercarriage**

Rectangle-tube-profile 60 x 40mm, 400mm legroom, wheelchair friendly, anthracite metallic, powder-coated.



**Wheels**

4 wheels Ø 125mm with rubber tread, all wheels are manoeuvrable, 2 wheels are lockable.



**Special features**

Balance of different standing positions and unevenness up to 30mm through height adjustment on the outer legs. Two gas pressure springs for weight neutralisation of the tabletops. When placing in storage position, several tables can be placed into each other. The table tennis table is ready assembled. Wheelchair friendly.



**Assembly video**

Practical supplement to the assembly instruction. Step by step to the finished table tennis table - clearly explained in the video. Available via QR code. [Link: http://q-r.to/060u](http://q-r.to/060u)



**Dimensions**

Storage position: L=152,5cm x W=55cm x H=161cm  
Playing position: L=274cm x W (with net)=185cm x H=76cm  
(Tabletop in accordance with international dimensions)



**Packaging**

Type E (single transport pallet)  
H=176cm x L=158cm x W=57cm



**Weight**

Table tennis table 117 kg, with packaging 141 kg



**DESIGN LINE**



**Quality  
made in  
Germany**

**Art.-Nr. 273.DEFG/HI**

Delivery will be made without bats and balls.  
Subject to technical alterations.



ready assembled

**SDL Black Indoor**



**Field of use**  
Indoors



**Tabletop**  
3tecWOOD 22mm, metal frame A 60mm



**Net set**  
SDL Black



**Undercarriage**  
compact (type 4), black matt



**Wheels**

4 wheels Ø 125mm, with rubber tread, all wheels are manoeuvrable, 2 wheels are lockable



**Locking system**

SMS (Smart Manual System)



**Special features**

Height adjuster, Multipurpose tray for bats and valuables. Holder for max. 2x3 tt-balls.



**Service:** Assembly instructions and information for users are included in delivery. Instruction for use, as well as the service code number (for technical questions or complaints) are to be found on the underside of the table top.

**Warranty claim:** 2 years (according to legal regulations).

**Security advice:** The table tennis table has to be placed on level ground and should be secured against rolling away or tipping over.



## SDL Black Indoor



### Field of use

Indoors. High quality demands in an international scope.



### Tabletop

3tecWOOD 22mm, coated several times with special varnish, grey. High stability through metal frame A 60mm.



### Net set

SDL Black net black, height adjustable, with stretching cord.



### Locking system

SMS (Smart Manual System). Handle visible from all sides and in any position. Drawbar underneath the tabletop unlocks both of the safety devices simultaneously. Simple and automatic click-mechanism in storage and playing position of the table.



### Undercarriage

Rectangle-tube-profile 60 x 40mm, black matt



### Wheels

4 wheels Ø 125mm with rubber tread, all wheels are manoeuvrable, 2 wheels are lockable with black brakes.



### Special features

Balance of different standing positions and unevenness up to 25mm through height adjustment on the outer legs. The table tennis table is ready assembled. Multipurpose tray for bats and valuables. Holder for max. 2x3 tt-balls.



### Dimensions

Storage position: L=185cm x W=64cm x H=159m  
Playing position: L=274cm x W (with net)=185cm x H=76cm  
(Tabletop in accordance with international dimensions)



### Packaging

Type E (single transport pallet)  
H=174cm x L=165cm x W=65cm



### Weight

Table tennis table 104 kg,  
with packaging 144 kg





10 years warranty<sup>1)</sup>

<sup>1)</sup>for outdoor melamine resin boards according to our warranty terms



**S3 LINE**

Class C  
EN 14468-1

**Quality  
made in  
Germany**

Art.-Nr. 274.DEFG/HI

Delivery will be made without bats and balls.  
Subject to technical alterations.



ready assembled

## SDL Black Outdoor



**Field of use**  
Outdoors



**Tabletop**  
\*\* melamine resin board 10mm,  
metal frame A 60mm



**Net set**  
SDL Black



**Undercarriage**  
compact (type 4), black matt



### Wheels

4 wheels Ø 125mm, with rubber tread,  
all wheels are manoeuvrable,  
2 wheels are lockable



### Locking system

SMS (Smart Manual System)



### Special features

Height adjuster, Multipurpose tray for bats  
and valuables. Holder for max. 2x3 tt-balls.

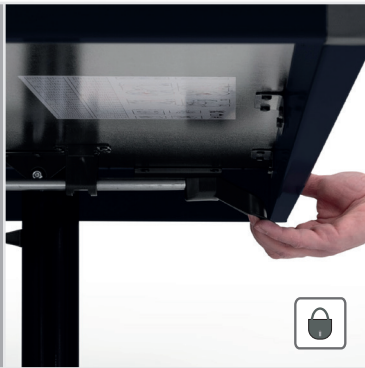

**Service:** Assembly instructions and information for users are included in delivery. Instruction for use, as well as the service code number (for technical questions or complaints) are to be found on the underside of the table top.

**Warranty claim:** 2 years (according to legal regulations).

**Security advice:** The table tennis table has to be placed on level ground and should be secured against rolling away or tipping over.



## SDL Black Outdoor



### Field of use

Outdoors. To be used throughout the year.



### Tabletop

\*\* Melamine resin board 10mm, grey, limited impact-resistant, top resistant against dampness and additional cross section.



### Net set

SDL Black net black, height adjustable, with stretching cord.



### Locking system

SMS (Smart Manual System). Handle visible from all sides and in any position. Drawbar underneath the tabletop unlocks both of the safety devices simultaneously. Simple and automatic click-mechanism in storage and playing position of the table.



### Undercarriage

Rectangle-tube-profile 60 x 40mm, black matt



### Wheels

4 wheels Ø 125mm with rubber tread, all wheels are manoeuvrable, 2 wheels are lockable with black brakes.



### Special features

Balance of different standing positions and unevenness up to 25mm through height adjustment on the outer legs. The table tennis table is ready assembled. Multipurpose tray for bats and valuables. Holder for max. 2x3 tt-balls.



### Dimensions

Storage position: L=185cm x W=64cm x H=159m  
Playing position: L=274cm x W (with net)=185cm x H=76cm  
(Tabletop in accordance with international dimensions)



### Packaging

Type E (single transport pallet)  
H=174cm x L=165cm x W=65cm



### Weight

Table tennis table 113 kg,  
with packaging 150 kg



**DESIGN LINE**



EN 14468-1  
Class A



**Quality  
made in  
Germany**

Art.-Nr. 273.DEFG/HI

Delivery will be made  
without bats and balls.  
Subject to technical alterations.



ready assembled

**SDL Pro Indoor**



**Field of use**  
Indoors



**Tabletop**  
3tecWOOD 22mm, metal frame A 60mm



**Net set**  
SDL Pro



**Undercarriage**  
compact (type 4), black matt



**Wheels**

4 wheels Ø 125mm, with rubber tread,  
all wheels are manoeuvrable,  
2 wheels are lockable



**Locking system**

SMS (Smart Manual System)



**Special features**

Height adjuster, Multipurpose tray for bats  
and valuables. Holder for max. 2x3 tt-balls.





**Service:** Assembly instructions and information for users are included in delivery. Instruction for use, as well as the service code number (for technical questions or complaints) are to be found on the underside of the table top.

**Warranty claim:** 2 years (according to legal regulations).

**Security advice:** The table tennis table has to be placed on level ground and should be secured against rolling away or tipping over.



## SDL Pro Indoor



### Field of use

Indoors. High quality demands in an international scope.



### Tabletop

3tecWOOD 22mm, coated several times with special varnish, grey. High stability through metal frame A 60mm.



### Net set

SDL Pro net black with lower edge in red, height adjustable, with stretching cord.



### Locking system

SMS (Smart Manual System). Handle visible from all sides and in any position. Drawbar underneath the tabletop unlocks both of the safety devices simultaneously. Simple and automatic click-mechanism in storage and playing position of the table.



### Undercarriage

Rectangle-tube-profile 60 x 40mm, black matt



### Wheels

4 wheels Ø 125mm with rubber tread, all wheels are manoeuvrable, 2 wheels are lockable with red brakes.



### Special features

Balance of different standing positions and unevenness up to 25mm through height adjustment on the outer legs. The table tennis table is ready assembled. Multipurpose tray for bats and valuables. Holder for max. 2x3 tt-balls.



### Dimensions

Storage position: L=185cm x W=64cm x H=159m  
Playing position: L=274cm x W (with net)=185cm x H=76cm  
(Tabletop in accordance with international dimensions)



### Packaging

Type E (single transport pallet)  
H=174cm x L=165cm x W=65cm



### Weight

Table tennis table 104 kg,  
with packaging 144 kg



10 years warranty<sup>1)</sup>

<sup>1)</sup>for outdoor melamine resin boards according to our warranty terms



**S3 LINE**

Class C  
EN 14468-1

**Quality  
made in  
Germany**

Art.-Nr. 274.DEFG/HI

Delivery will be made without bats and balls.

Subject to technical alterations.



ready assembled

## SDL Pro Outdoor



**Field of use**  
Outdoors



**Tabletop**  
\*\* melamine resin board 10mm,  
metal frame A 60mm



**Net set**  
SDL Pro



**Undercarriage**  
compact (type 4), black matt



### Wheels

4 wheels Ø 125mm, with rubber tread,  
all wheels are manoeuvrable,  
2 wheels are lockable



### Locking system

SMS (Smart Manual System)



### Special features

Height adjuster, Multipurpose tray for bats  
and valuables. Holder for max. 2x3 tt-balls.



**Service:** Assembly instructions and information for users are included in delivery. Instruction for use, as well as the service code number (for technical questions or complaints) are to be found on the underside of the table top.

**Warranty claim:** 2 years (according to legal regulations).

**Security advice:** The table tennis table has to be placed on level ground and should be secured against rolling away or tipping over.



## SDL Pro Outdoor



### Field of use

Outdoors. To be used throughout the year.



### Tabletop

\*\* Melamine resin board 10mm, grey, limited impact-resistant, top resistant against dampness and additional cross section.



### Net set

SDL Pro net black with lower edge in red, height adjustable, with stretching cord.



### Locking system

SMS (Smart Manual System). Handle visible from all sides and in any position. Drawbar underneath the tabletop unlocks both of the safety devices simultaneously. Simple and automatic click-mechanism in storage and playing position of the table.



### Undercarriage

Rectangle-tube-profile 60 x 40mm, black matt



### Wheels

4 wheels Ø 125mm with rubber tread, all wheels are manoeuvrable, 2 wheels are lockable with red brakes.



### Special features

Balance of different standing positions and unevenness up to 25mm through height adjustment on the outer legs. The table tennis table is ready assembled. Multipurpose tray for bats and valuables. Holder for max. 2x3 tt-balls.



### Dimensions

Storage position: L=185cm x W=64cm x H=159cm  
Playing position: L=274cm x W (with net)=185cm x H=76cm  
(Tabletop in accordance with international dimensions)



### Packaging

Type E (single transport pallet)  
H=174cm x L=165cm x W=65cm



### Weight

Table tennis table 113 kg, with packaging 150 kg





**DESIGN LINE**



**Quality  
made in  
Germany**

**Art.-Nr. 273.DEFG/HI**

Delivery will be made without bats and balls.  
Subject to technical alterations.



ready assembled

**SDL Raw Indoor**



**Field of use**  
Indoors



**Tabletop**  
3tecWOOD 22mm, metal frame A 60mm



**Net set**  
SDL Raw



**Undercarriage**  
compact (type 4), black matt



**Wheels**

4 wheels Ø 125mm, with rubber tread, all wheels are manoeuvrable, 2 wheels are lockable



**Locking system**

SMS (Smart Manual System)



**Special features**

Height adjuster, Multipurpose tray for bats and valuables. Holder for max. 2x3 tt-balls.

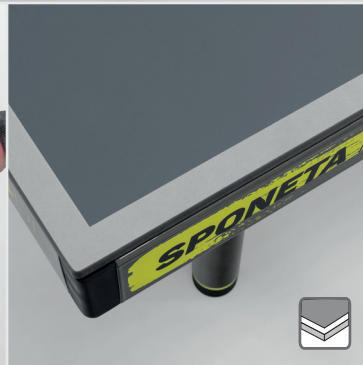

**Service:** Assembly instructions and information for users are included in delivery. Instruction for use, as well as the service code number (for technical questions or complaints) are to be found on the underside of the table top.

**Warranty claim:** 2 years (according to legal regulations).

**Security advice:** The table tennis table has to be placed on level ground and should be secured against rolling away or tipping over.



## SDL Raw Indoor



### Field of use

Indoors. High quality demands in an international scope.



### Tabletop

3tecWOOD 22mm, coated several times with special varnish, grey. High stability through metal frame A 60mm.



### Net set

SDL Raw net black with lower edge in yellow, height adjustable, with stretching cord.



### Locking system

SMS (Smart Manual System). Handle visible from all sides and in any position. Drawbar underneath the tabletop unlocks both of the safety devices simultaneously. Simple and automatic click-mechanism in storage and playing position of the table.



### Undercarriage

Rectangle-tube-profile 60 x 40mm, transparent high gloss



### Wheels

4 wheels Ø 125mm with rubber tread, all wheels are manoeuvrable, 2 wheels are lockable with black brakes.



### Special features

Balance of different standing positions and unevenness up to 25mm through height adjustment on the outer legs. The table tennis table is ready assembled. Multipurpose tray for bats and valuables. Holder for max. 2x3 tt-balls.



### Dimensions

Storage position: L=185cm x W=64cm x H=159cm  
Playing position: L=274cm x W (with net)=185cm x H=76cm  
(Tabletop in accordance with international dimensions)



### Packaging

Type E (single transport pallet)  
H=174cm x L=165cm x W=65cm



### Weight

Table tennis table 104 kg,  
with packaging 144 kg



10 years warranty<sup>1)</sup>

<sup>1)</sup>for outdoor melamine resin boards according to our warranty terms



**S3 LINE**

Class C  
EN 14468-1

**Quality  
made in  
Germany**

Art.-Nr. 274.DEFG/HI

Delivery will be made without bats and balls.  
Subject to technical alterations.



ready assembled

## SDL Raw Outdoor



**Field of use**  
Outdoors



**Tabletop**  
\*\* melamine resin board 10mm,  
metal frame A 60mm



**Net set**  
SDL Raw



**Undercarriage**  
compact (type 4), black matt



**Wheels**  
4 wheels Ø 125mm, with rubber tread,  
all wheels are manoeuvrable,  
2 wheels are lockable



**Locking system**  
SMS (Smart Manual System)



**Special features**  
Height adjuster, Multipurpose tray for bats  
and valuables. Holder for max. 2x3 tt-balls.



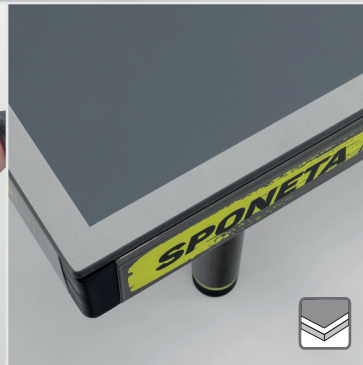

**Service:** Assembly instructions and information for users are included in delivery. Instruction for use, as well as the service code number (for technical questions or complaints) are to be found on the underside of the table top.

**Warranty claim:** 2 years (according to legal regulations).

**Security advice:** The table tennis table has to be placed on level ground and should be secured against rolling away or tipping over.



## SDL Raw Outdoor



### Field of use

Outdoors. To be used throughout the year.



### Tabletop

\*\* Melamine resin board 10mm, grey, limited impact-resistant, top resistant against dampness and additional cross section.



### Net set

SDL Raw net black with lower edge in red, height adjustable, with stretching cord.



### Locking system

SMS (Smart Manual System). Handle visible from all sides and in any position. Drawbar underneath the tabletop unlocks both of the safety devices simultaneously. Simple and automatic click-mechanism in storage and playing position of the table.



### Undercarriage

Rectangle-tube-profile 60 x 40mm, black matt



### Wheels

4 wheels Ø 125mm with rubber tread, all wheels are manoeuvrable, 2 wheels are lockable with red brakes.



### Special features

Balance of different standing positions and unevenness up to 25mm through height adjustment on the outer legs. The table tennis table is ready assembled. Multipurpose tray for bats and valuables. Holder for max. 2x3 tt-balls.



### Dimensions

Storage position: L=185cm x W=64cm x H=159cm  
Playing position: L=274cm x W (with net)=185cm x H=76cm  
(Tabletop in accordance with international dimensions)



### Packaging

Type E (single transport pallet)  
H=174cm x L=165cm x W=65cm



### Weight

Table tennis table 113 kg,  
with packaging 150 kg



1



2



3



4

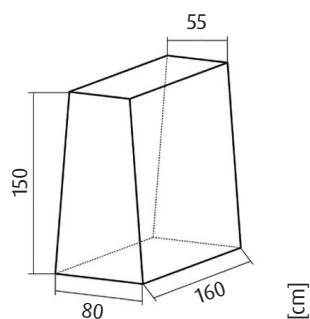

[cm]

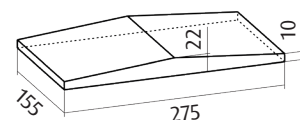

[cm]

**1 Sports bag**

shoulder carrier bag with Sponeta logo, two spacious side pockets on front side, one pocket alongside

Packaging: Plastic bag  
l=65cm, w=32cm  
net weight: 1,3kg

**2 Protection cover SDL**

Suitable for all compact table tennis tables

100% polyester fabric (stone), h=150cm, l=160cm, w=80/25cm with velcro fastener

Packaging: Plastic bag  
Dimensions:  
l=41cm w=32cm h=8cm  
Weight: 2,2kg

**3 Protection cover Universal**

Suitable for all foldable automatic and compact table tennis tables

Polyethylene, h=150cm, l=160cm, w=80/55cm with fixing string

Packaging: Plastic bag  
Dimensions:  
l=35cm w=26cm h=5cm  
Weight: 0,95kg

**4 Protection cover type 1**

Suitable for all standard (Typ 1) tables

Protection cover with fixing string  
Polyethylene, h=10-22cm, l=275cm, w=155cm for all stationary table tennis tables

Packaging: Plastic bag  
Dimensions:  
l=35cm w=26cm h=5cm  
Weight: 0,7kg



1



2



3



4



5



6

**1 4Seasons**

Bat for beginners, extremely robust, weatherproof composite racket made of PP/TPE with an ergonomically designed and slip-resistant grip

**2 Set Record**

table tennis set, 2 bats, pips in, with sponge 1,5mm, straight grip, 3 balls

**3 Flash**

bat for newcomer, straight grip

**4 Balls 1 star**

white, Ø 40mm, 6 pcs./pack

**5 Balls 3 star**

white, Ø 40mm, 6 pcs./pack

**6 practice balls**

white, Ø 40mm, 12 pcs./plastic bag

TT balls are classified as Dangerous Goods of class 4.1 / UN no. 2000 and not released for sea or air transport.





7



8



9



10



11



12

**7 Action**

Bat for beginners, rubber Trainer, pips in, without sponge, blade allround, concave grip, spin 30%, speed 30%, control 95%

**8 Fight**

Bat for hobby players, rubber Trainer, pips in, with sponge 1,0 mm, blade defensive, anatomical grip, Ergo Grip, spin 35%, speed 35%, control 90%

**9 Force**

Amateur bat, rubber Samurai ITTF-approved, pips in, with sponge 1,5mm, blade offensive, concave grip, Ergo Grip, spin 40%, speed 50%, control 85%

**10 Power**

Training bat, with sponge 1,5 mm, rubber Mandarin ITTF-approved, with Power Grip, blade allround, handle concave, Comfort Handle, Ergo Grip, spin 50%, speed 70%, control 70%

**11 Passion**

Competition bat, with sponge 1,5 mm, rubber Taipan ITTF-approved, blade offensive, handle anatomic, EVA Layer, Ergo Grip, spin 60%, speed 75%, control 65%

**12 Challenge**

Professional bat, with sponge 1,5 mm, rubber Shogun ITTF-approved, blade offensive, handle concave, Comfort Handle, Shock Absorber Tube, Ergo Grip, spin 60%, speed 85%, control 70%

All technical information correspond to EN 14468-2.

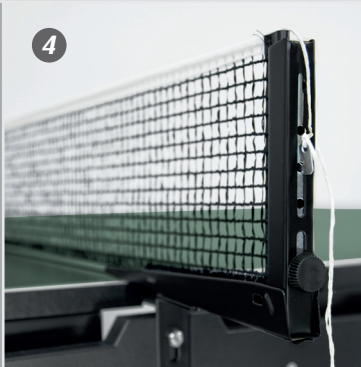
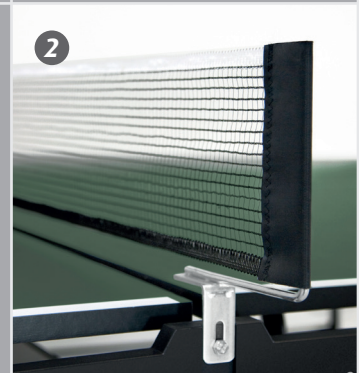
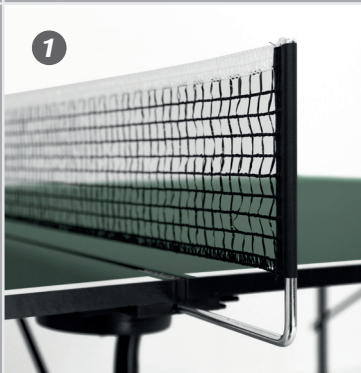

**1 Start**

metal handle Ø 6mm, galvanized, net black, with loop (Ø 8mm), length approx. 180cm, height 15,2cm, weight: 0,7kg

**2 Club-EN-stationary**

metal handle Ø 6mm with fixing plate, galvanized, net black, with loop (Ø 8mm), length approx. 180cm, height 15,2cm, weight: 0,6kg

**3 Pilot-II-EN-stationary**

net holding profile with fixing plate and post, powdercoated, net: black, with loop (Ø 8mm), length approx. 180cm, height 15,2cm, plastic keder Ø 6mm in accordance with the height of the net, weight: 1kg

**4 Perfect-II-EN-stationary**

net holding profile with fixing plate, post outside and post inside for adjusting, the height with a height adjusting screw, powder-coated, net: black, with loop (Ø 8mm), length approx. 180cm, height 15,2cm, plastic keder Ø 6mm in accordance with the height of the net, weight: 1,1kg

**5 Perfect-II-EN-stationary-compact**

net holding profile with fixing plate, post outside and post inside for adjusting, the height with a height adjusting screw, powder-coated, net: black, with loop (Ø 8mm), length approx. 180cm, height 15,2cm, plastic keder Ø 6mm in accordance with the height of the net, weight: 1,1kg

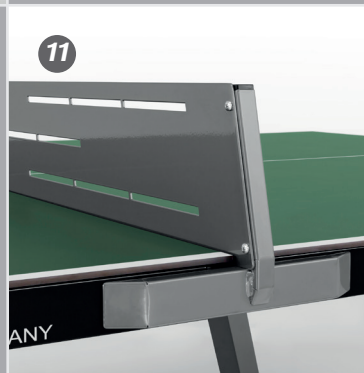
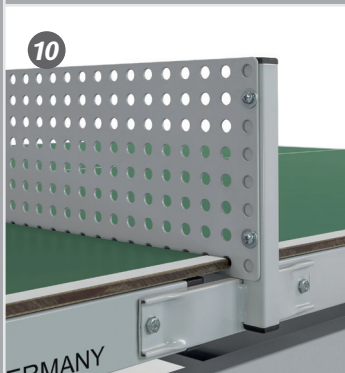
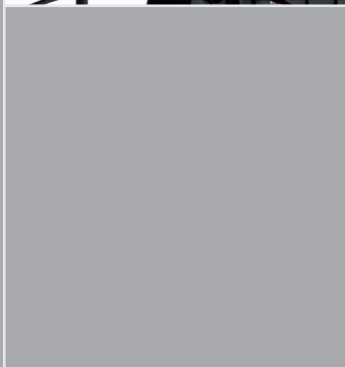

**6 Basic stationary**

metal handle Ø 6mm with fixing plate, galvanized, with holder for bat and balls (plastic), net black, with loop (Ø 8mm), length approx. 180cm, height 15,2cm

**7 Primus-II-EN-stationary-compact**

high-quality net and post, plastic-coated, with stable post, net height-adjustable with clamp, high-quality cotton net, type "Weltmeister", black or blue, with stretching cord and chain, weight: 1,25kg

**8 Primus-EN-stationary-compact**

high-quality net and post, plastic-coated, with stable post, net height-adjustable with clamp, plastic net (black) with stretching cord and chain, weight: 1,25kg

**9 Classic**

ITTF approved, high-quality net and post, plastic-coated, with stable post and metal keder, height-adjustable with clamp, high-quality cotton net, type 'Weltmeister', black or blue, with stretching cord and chain, maximum thickness of the top 25mm, weight: 2kg

**10 Metal net-I**

stable metal net made of galvanized sheet steel (thickness 2mm), with fastening screws length 160cm, height 16cm, weight 5,5kg, packaging: l=165cm, w=22cm, h=5cm

**11 Metal net-II**

stable metal net made of galvanized sheet steel (thickness 2mm), with fastening screws length 160cm, height 16cm, weight 5,5kg, packaging: l=165cm, w=22cm, h=5cm



Depending on the model of the table tennis table and the constructive requirements, different locking systems are used.

Fundamentally, one person can handle all of the locking systems.



**1 SMS (Smart Manual System)**

in use in S 2-72/73 i/e, S 3-72/73 i/e, S 3-86/87 i/e, S 4-72/73 i/e, S 5-72/73 i/e, S 8-36/37, S 8-36 w/37 w

The one-handed operation makes this system so comfortable. The striking handle is visible in any position of the table and from all sides. Drawbar underneath the tabletop unlocks both of the safety devices simultaneously. In the storage position, the tabletops must principally be brought into a vertical position, so that the locks automatically click into place. In the playing position, the locks already click very well into place prior to attaining the horizontal position. In this case, they also ensure high stability on uneven ground.

**2 Handle system**

in use in S 6-12/13 i, S 6-52/53 i, S 7-12/13, S 7-62/63

Through a two-handed operation of the metal handle underneath the metal frame, both locks on the right and left hand sides can be simultaneously unlocked. The two tabletops are brought, with the help of the handle system, from the storage position into the playing position and vice versa. In the storage position, the tabletops must principally be brought into a vertical position, so that the locks automatically click into place. In the playing position, the locks already click very well into place prior to attaining the horizontal position. In this case, they also ensure high stability on uneven ground.

**3 Rotating handle system**

in use in S 1-42/43 i/e, S 1-72/73 i/e

By turning the handle 90°, the lock of the tabletop opens depending on the direction of the rotation. After unlocking the opposite side, the tabletop can be brought from the storage position to the playing position as well as from the playing position to the storage position.



#### **4 Hook system**

in use in S 1-12/13 i/e, S 1-26/27 i, S 3-46/47 i/e

By lifting the hook on one side, simultaneously and gently pulling it towards the tabletop, the first lock opens. In the same way, the second lock mechanism can also be unlocked and subsequently the tabletop can be brought from the storage position into the playing position. Folding-up of the tabletops from the playing position into the storage position results without further unlocking or opening. In order to achieve this, you merely need to lift the tabletops and place them in a vertical position until the locks audibly click into place. The stability of the table is assured against pressure and tension through the presence of the constant and appropriate net set.

#### **5 Clasp system**

in use in S 7-22/23

The clasps serve for the stabilisation of the stand legs in the storage as well as in the playing positions. By lifting the metal hook, the safety devices unlock themselves and the stand legs of the table can be folded inward. Through a strong push of the metal stick, the diagonal support clasps lock audibly into place.

#### **6 Screw connection**

in use in S 1-52/53 i

The screw connection serves for the stabilisation of the stand legs in the playing position of the table. Through the loosening of the wing nuts, the legs open and can be folded inward.







**1 Type A:**  
Single carton for vertical transport. Stable single carton for one piece of table tennis table with 2 tops, frame profiles (not all models), undercarriage, marking of the table-model, EAN-code.

**2 Type B:**  
Double carton for vertical transport. 2 pieces of stable single cartons for one piece of table tennis table, one top with frame profiles and undercarriage in one carton, marking of the table model, EAN-code.

**3 Type C:**  
Pallet-distribution for vertical transport. 4 or 5 stable single cartons per pallet (according to the model), marking of the model, EAN-Code, cartons are protected by side-boards at the pallet, distance ca. 10 cm (H2). Dimension of pallet: H=170 cm x B=48 cm x L=148 cm. Only one model per pallet!

**4 Type D:**  
Pallet-distribution for horizontal transport. One way pallet with table tennis tables - horizontal transport. Stable cartons for table tennis table of packaging-versions A and/ or B. These table tennis tables

are also suitable for single transportation (upright position). Pallets are on commission per order; several models of different quantities can be packed on one pallet! Pallets are tied with PE-strips and stretched in plastic. Dimension of pallet (1): L=162 cm, B=144 cm, H3=12 cm (45 kg) Height of stack: min. 6 tables (A o. B) or min. ca. 70 cm max 15 tables = max. 180 cm Weight of pallet: max. 1.200 kg All pallets with one cover board (2).

**5 Type E:**  
Single transport pallet. One way pallet for shipping single, fully assembled tt tables. The pallets are stretched into foil. The dimension of the range depends on the respective packaged model. The width is between 55 cm and 75 cm. Weight of each pallet: 24 kg

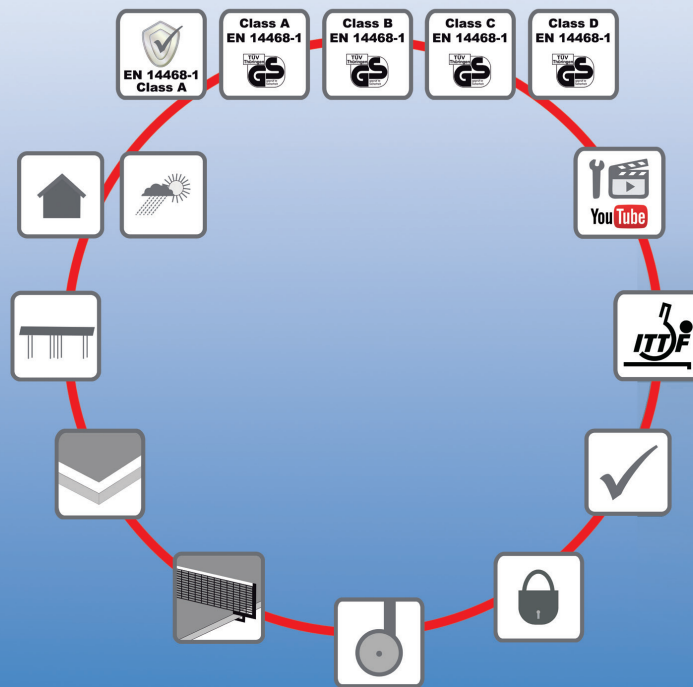

**Fields of use**

TT tables can be used indoors (not weather proof) or outdoors (all-year, all-weather). The table tennis tables which are not weatherproof should not be exposed to direct sun and moisture. The all-weather table tennis tables, however, can be placed or stored outdoors but should be secured against wind gusts or storms. In case of direct sun exposure, faults can occur on the tabletop of the outdoor tables which will form back at normal climate conditions.

**GS, Class A - D**

Table tennis tables are subject to the German Equipment and Product Safety Act (GPSG). In Europe the EU standard EN 14468-1 is valid. All products manufactured by Sponeta achieve this standard and basic safety requirement. All products manufactured by Sponeta are labelled with the GS mark as a quality test proof (tested safety). They are divided into several classes according to their range of application:  
 Class A High competition  
 Class B School and club sports  
 Class C Recreational sports (high quality)  
 Class D Recreational sports



**Tabletop surface**

Generally, and this is true for all table tennis tables, the play characteristics are better for thick play surfaces. On a 19 mm- indoor - fine 3tecWOOD, the ball rebound behaviour is better than on a 16 mm thick top and the 22 mm indoor fine 3tecWOOD table is again better than the 19 mm thick top. It is also the same for the all-weather tennis tables. A 6 mm thick melamine resin board shows better play characteristics than the 5 mm or 4 mm thick melamine resin board. The following criteria have been taken into account: thickness of the top = ball rebound, table top coating = degree of gloss, kinetic friction coefficient, abrasion resistance.

**Indoor**, not weatherproof, play lines are printed by silkscreenprinting

- 1 3tecWOOD 16 - 19mm, coated several times, field of use: classes C and D
- 2 3tecWOOD 22mm, coated several times with special varnish, field of use: class B
- 3 3tecWOOD 22 - 25mm, coated several times with special varnish, field of use: class A plus all ITTF-approved tables

**Outdoor**, weatherproof, with integrated play lines

- 1\* melamine resin board 3,5 - 4mm, resistant against humidity, sticked together with a metal construction, field of use: classes C and D
- 2\*\* melamine resin board 5 - 10mm, resistant against humidity, sticked together with a metal construction, field of use: classes B and C

**Melamine resin boards**

For the all-weather table tennis tables, Sponeta uses melamine resin boards as play surfaces. Other manufacturers deliver the all-weather table tennis tables with aluminiumcompound plates. Although, the materials are generally different, their play characteristics are nearly the same. In principle, the weather-proof table-tennis tables do not achieve the play characteristics of the indoor tables. Depending on their thickness, melamine resin boards consist of 8 -12 papers soaked in resin which are pressed under high pressure and heat to form rigid plates. Melamine resin boards are also used in bathrooms, on front faces of buildings, etc.

**Ball rebound**

is one of the most important decision criterions for the buyer of a table tennis table. For the professional player, gloss degree, kinetic coefficient of friction and flatness tolerance count additionally. Certainly, the design and the price are deciding factors. The European standard requires the following ball rebound

heights (falling height 300 mm):

- Class A 230 - 260 mm
- Class B 230 - 260 mm
- Class C 210 mm
- Class D 180 mm

(Average measurement on 16 + 4 measuring points) Although, the ball has only got a weight of 2.7 g, the ball rebound depends on the thickness of the table top and with it of the mass. The location, where the table tennis tables are placed is crucial as well. That means: the ball rebound is higher on a hard floor, e.g. concrete floor, than on a wood/parquet floor in a sports hall or on a meadow outdoors.

**Undercarriages**

The undercarriage holds the playing surface of the table tennis table and adds stability. Depending on the type it also offers various transport and storage facilities. Table tennis tables are divided into 6 types:

**Type 1 Standard I** Stationary model with undercarriage for the table top, which is not foldable.

**Type 2 Standard II** (in two parts) Stationary model with two separated table top halves with undercarriage, foldable.

**Type 3 Semi-Compact** (in two parts) Movable table with the table top in two separate halves, each of them is equipped with a foldable undercarriage.

**Type 4a Automatic** Movable table with undercarriage for both halves of the table, each of them is independently foldable. Characteristics of the storage position: Distance of the table halves is about 400 mm with safety bar, storage height is about 1900 mm.





**Type 4b Compact** Movable table with undercarriage for both halves of the table, each of them is independently foldable. Characteristics of the storage position: Distance of table halves is about 100 mm, storage height is about 1650 mm.

**Type 5 Super-Compact** Movable table with fully automatic undercarriage for both halves of the table, they can only be folded together.

#### Net sets

All table tennis tables manufactured by Sponeta come with net set. Net sets approved by the International Table Tennis Federation (ITTF) are labelled with the ITTF-logo as a proof.

#### Wheels

Depending on demand, weight, and class, the table tennis tables are equipped with different types of wheels:

- Ø 125 mm
- Ø 128 mm with rubber surface
- Ø 100 mm with and without brakes
- Ø 125 mm with and without brakes

#### Locking systems

Depending on the model of the table tennis table and the constructive requirements, different locking systems are used. Fundamentally, one person can handle all of the locking systems.

#### Special features

Depending on the model and its design table tennis tables are equipped with different features.

#### Height adjustment

Different heights of the ground or unevenness can be regulated by the height adjustments in the range of max. 30 mm.

#### Gas pressure springs

The own weight of the table tops is compensated by gas pressure springs.

#### Bat and ball holders

are fixed on the sides and serve as boxes for balls and bats.

#### Table top connection

Higher stability of the table tops is provided by table top connections and net set.

#### Safety bar

avoids that somebody can get between the two parts of the table top.

#### ITTF

Models approved by the International Table Tennis Federation (ITTF) are labelled with the ITTF-logo as a proof. This is based on the test according to Class A with an additional test of labelling, colour, and sliding friction coefficient.

#### Service

All models manufactured by Sponeta are subject to continuous quality control on the basis of an integrated quality management.

#### Warranty

On melamine resin boards we give a ten-year guarantee (on mechanical properties, impact and fracture resistance, weather resistance and light fastness according to our warranty regulations). Otherwise the warranty claim complies with legal requirements of 2 years.

#### Maintenance

No special maintenance is required. The table top surfaces can be cleaned with a wet cloth, the locking systems shall be checked for operability at least once a year.

#### Weight

Depending on the model table tennis tables can vary in design, table top and therefore weight.

#### Dimensions

All table tennis tables manufactured by Sponeta correspond to the European Standard 14468-1 and have got international dimensions (274cm x 152,5 x 76cm) in the playing position (completely open). In the storage position (completely folded) dimensions of the different models can vary.

#### Packaging

Depending on the model and the design, different cardboards and pallets are used. The individual tables are packed into single or double cardboard boxes (160 x 144 cm, width 9-25 cm depending on the model). Certain table models are mounted to be ready for the game and delivered on single transport pallets.

#### Installation

The TT tables are delivered in a disassembled status. They are mounted using the assembly instructions with clear exploded view diagrams.

The assembly instructions are written in eight languages, so that foreign customers can also understand them easily. Generally, two adult persons should carry out the assembly. The time required for assembly mainly depends on the persons' abilities - 1 - 2 hours can be assumed.

As a practical addition to the assembly instructions, there are corresponding **installation videos** for all Sponeta-TT models. Step by Step the videos clearly explain how to build a table tennis table correctly. All videos can be found via QR code on the assembly instructions in our Youtube channel

[www.youtube.com/sponeta1953](http://www.youtube.com/sponeta1953)



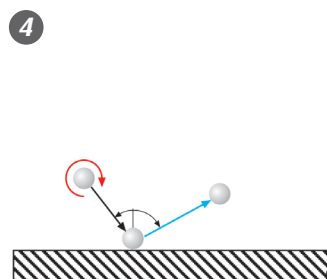
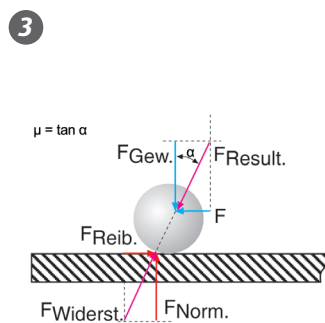
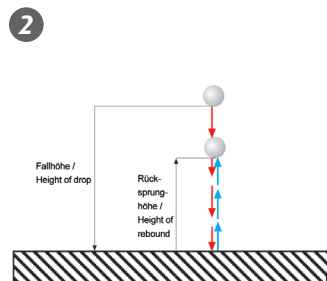
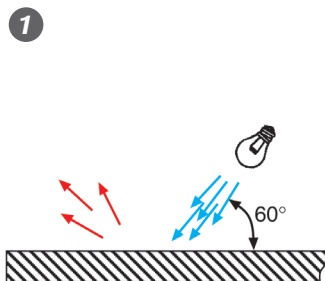
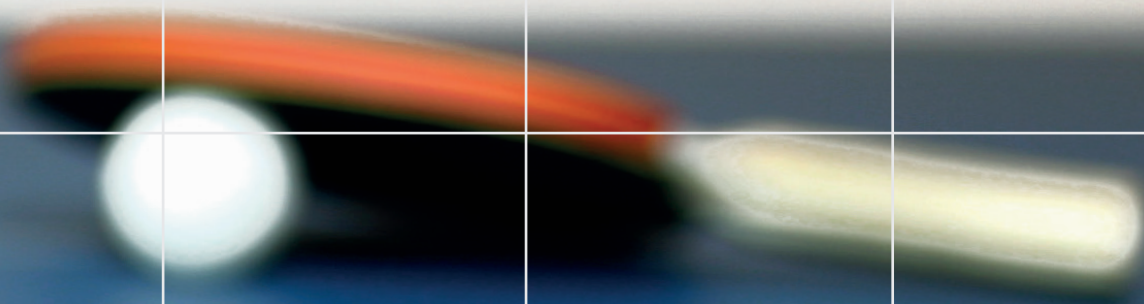

**Lines**

- S 1** Class D
- S 2** Class D
- S 3** Class D, C
- S 4** Class B
- S 5** Class B
- S 6** Class B
- S 7** Class A
- S 8** Class A

**Intended field of use**

- A:** High competition
- B:** School and club sports
- C:** Recreational sports (high quality)
- D:** Recreational sports

**Know-how**

The table tops are rated in a system from \* to \*\*\*. The following criteria have been taken into account:

- thickness of the top = ball rebound **(1)**
- table top coating = degree of gloss **(2)**
- sliding friction coefficient **(3)**
- rotation effect **(4)**
- abrasion resistance

**Table-dimensions:**

All tables correspond to the international dimensions, length: 274cm, with: 152,5cm, height: 76cm.

All technical details correspond to EN-Norm 14468-1.





In the center of Europe -  
Quality from the heart of Germany



Sponeta GmbH  
Gartenstraße 52  
99994 Schlotheim  
Germany

Tel.: +49 (0) 36021 / 87-0  
Fax: +49 (0) 36021 / 87-1151

tischtennis@sponeta.de  
[www.sponeta.de](http://www.sponeta.de)

1st Edition, January 2022

Errors excepted, technical changes at any time - even without prior notice - possible.

Due to the printing process the illustrations in this brochure may vary from the original colors of the products.



Exhibitor at

